

3658-02 2-Wire Foreign Exchange Office (2W FXO) Channel Units

 Complies with UL Standard 1459 Second Edition*

CONTENTS	PAGE
Part 1. GENERAL	2
Part 2. INSPECTION	2
Part 3. APPLICATION GUIDELINES	3
Part 4. CIRCUIT DESCRIPTION	3
Part 5. MOUNTING	6
Part 6. INSTALLER CONNECTIONS	6
Part 7. OPTIONS	6
Part 8. ALIGNMENT	8
Part 9. TESTING	8
Part 10. TECHNICAL ASSISTANCE	9
Part 11. WARRANTY & CUSTOMER SERVICE	9
Part 12. SPECIFICATIONS	10

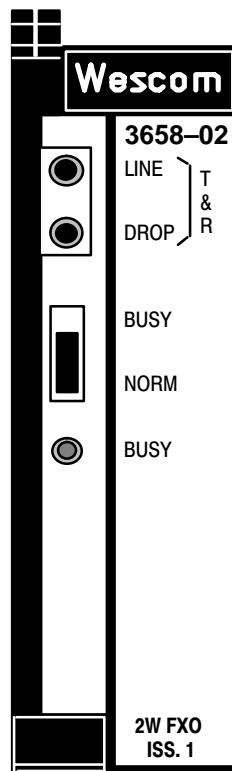

Figure 1. 3658-02 2W FXO Channel Unit

1. GENERAL

1.1 Document Purpose

This document provides information on the Charles 3658–02 2-Wire Foreign Exchange Office (2W FXO) Channel Unit, shown in Figure 1.

***CAUTION**

Field repairs/modifications may void compliance with UL 1459 – Second Edition.

1.2 Document Status

This document is reprinted to include a general editorial update.

1.3 Equipment Function

This channel unit is used in the Charles 360/363 Digital Carrier Terminal to provide an interface to a CO line circuit or PBX station circuit.

1.4 Equipment Location/Mounting

Occupies one channel unit slot of a Charles 360/363 D4 Digital Carrier Terminal Channel Bank Assembly.

1.5 Equipment Features

The 3658–02 (Issue 1) Channel Unit includes the following features:

- Compliance with AT&T Publication 43801 specifications
- Compliance with UL 1459 - Second Edition
- 900-ohm 2W impedance
- Prescription attenuation for the transmit and receive levels
- Accommodates input TLPs from –4.5 to +4.0dBm, and output TLP Levels from –4.0 to +4.5dBm
- Front-panel-accessible bantam breaking- jacks for accessing the transmit and receive ports
- Built-in jack for mounting an optional 3690–00/10 Compromise Network Subassembly or an optional 3690–01/11, –02/12, or –03/13 Precision Balance Network Subassembly
- Front-panel-accessible NORM/BUSY switch
- Front-panel BUSY LED indicator
- Automatic trunk processing and lead conditioning via optionable RING GROUND and LOOP CLOSURE relays during carrier failure
- Switch-selectable loop-start or ground-start operation
- Compatibility with 100-millisecond ringing intervals
- Compatible with D1D, D3, and D4 FXS channel units
- Build-out resistance of 400 ohms for loops less than 1.1k ohms

2. INSPECTION

2.1 Inspect for Damages

Inspect the equipment thoroughly upon delivery. If the equipment has been damaged in transit, immediately report the extent of damage to the transportation company.

2.2 Equipment Identification

Charles Industries' equipment is identified by a model and issue number imprinted on the front panel or located elsewhere on the equipment. Each time a major engineering design change is made on the equipment, the issue number is advanced by 1 and imprinted on subsequent units manufactured. Therefore, be sure to include both the model number and its issue number when making inquiries about the equipment.

2.3 Static Concerns

Each module is shipped in static-protective packaging to prevent electrostatic charges from damaging static-sensitive devices. Use approved static-preventive measures, such as static-conductive wrist straps and a static-dissipative mat, when handling modules outside of their protective packaging. A module intended for future use should be tested as soon as possible and returned to its original protective packaging for storage.



This equipment contains static-sensitive electronic devices. To prevent electrostatic charges from damaging static-sensitive units:

- Use approved static preventive measures (such as a static-conductive wrist strap and a static-dissipative mat) at all times whenever touching units outside of their original, shipped static-protective packaging.
- Do not ship or store units near strong electrostatic, electromagnetic, or magnetic fields.
- Use static-protective packaging for shipping or storage.

3. APPLICATION GUIDELINES

The 3658–02 provides a 900-ohm balanced interface between a 2-wire PBX/CO line (loop-start/ground start) and the common equipment units of the 360/363 D4 terminal. Refer to Figure 2 for typical application.

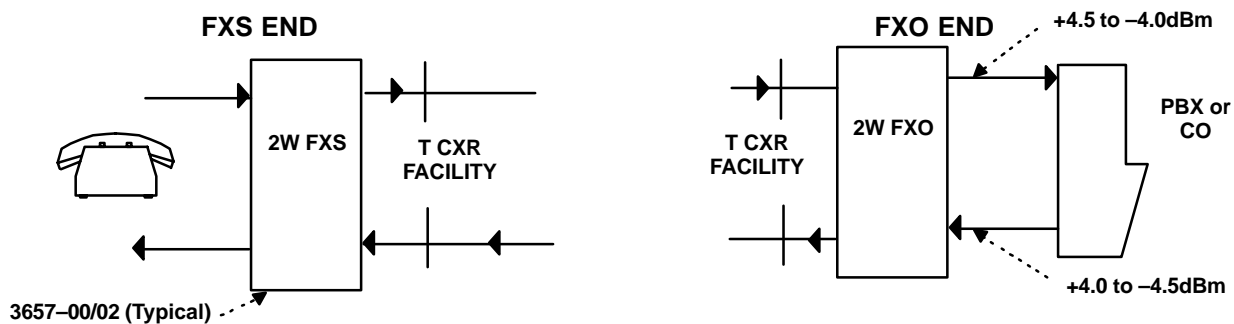

Figure 2. 3658–02 2W FXO Typical Application

4. CIRCUIT DESCRIPTION

Refer to Figure 3, the 3658–02 (Issue 1) Block Diagram, and Table 1 as needed while reading the following circuit description.

4.1 Transmit VF Path

Voice Frequency (VF) signals applied to the input T&R (pins 48 and 50) are routed through the DROP and LINE breaking-jacks to the 2W/4W HYBRID circuit. The 2W/4W HYBRID circuit converts the balanced 2-wire input to an unbalanced 4-wire interface.

Voice energy from the 2W/4W HYBRID is routed into the XMT GAIN and XMT ATTEN circuits. These circuits, acting together, set the transmit path gain to the exact level required to drive the XMT FILTER and ENCODER circuits. The use of the XMT ATTEN allows finely controlled adjustment for a range of office TLPs from -4.5 to $+4.0$ dBm.

The adjusted VF signal is then applied to the XMT FILTER for suppression of frequencies which are outside of the bandwidth of the standard voice frequency and prevents them from entering the ENCODER.

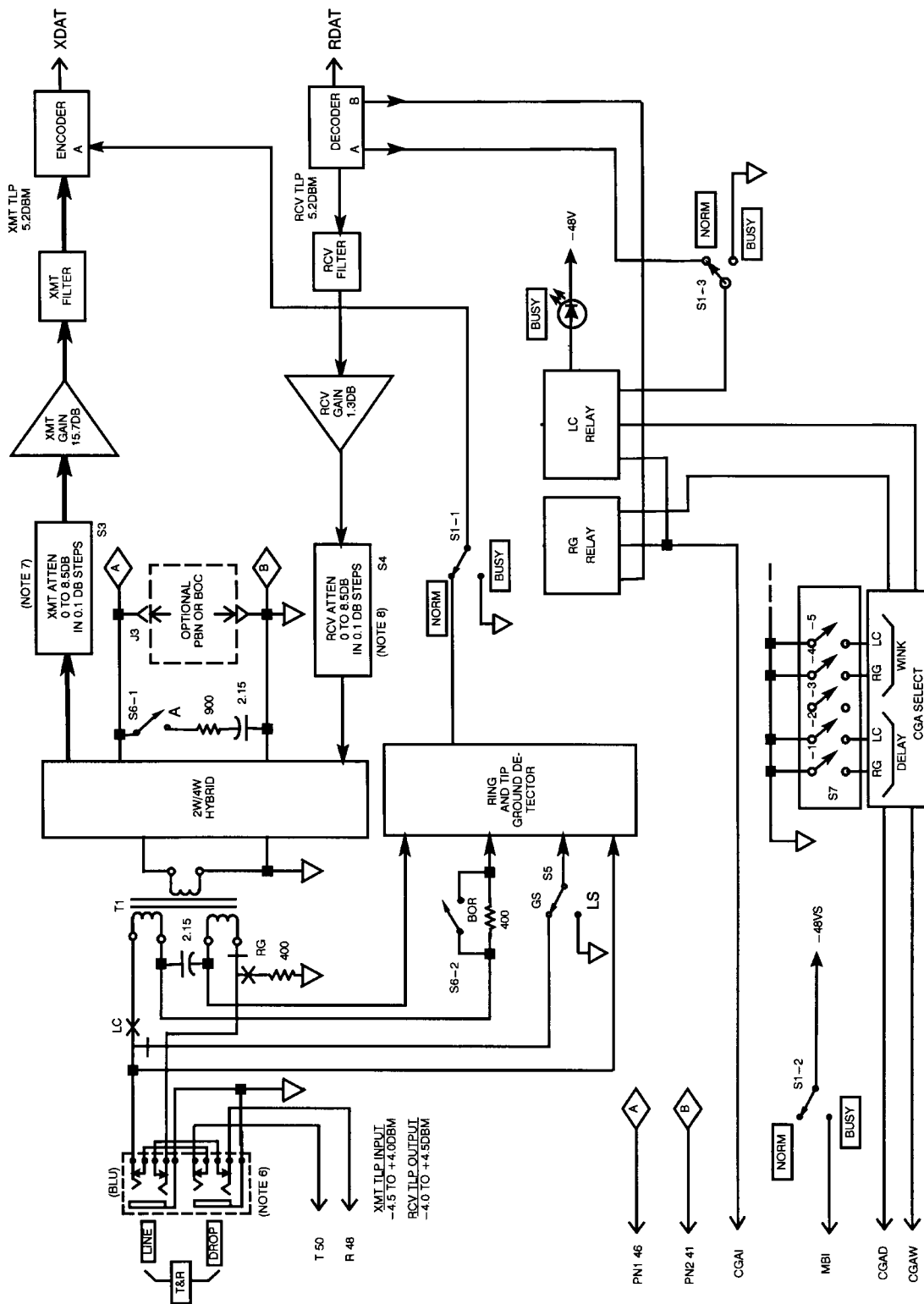
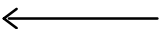





Figure 3. 3658-02 2W FXO (Issue 1) Block Diagram

Table 1. Notes For Block Diagram (Figure 3)

#	Note	
1.		PCB connector pin
2.		Front panel marking
3.		Signal flow direction
4.		N.O., N.C. relay contact
5.	Ganged switches are indicated by alphabetically suffixed reference designations. The numerical suffix denotes a discrete switch within a package.	
6.	Front panel test jacks:	
	Marking	Function
	T&R Line	Access towards channel unit
	T&R Drop	Access towards office equipment
7.	The XMT input range at T&R is -4.5 to 4.0 dBm. The XMT ATTEN (S3) is adjustable from 0 to 8.5 dB in 0.1 dB increments. For a 0.0 dBm input at T&R, the XMT ATTEN should be set for 4.5 dB of attenuation.	
8.	The RCV output range at T&R is -4 to 4.5 dBm. The RCV ATTEN (S4) is adjustable from 0 to 8.5 dB in 0.1 dB increments. For -2.0 dBm output at T&R, the RCV ATTEN should be set for 6.5 dB of attenuation.	

The filtered VF signal is then applied to the ENCODER. The ENCODER performs an analog-to-digital (A/D) conversion of the VF signal and sends the resulting Pulse Code Modulation (PCM) signal to the 360/363 D4 terminal common equipment via the XDATA lead.

4.2 Receive VF Path

The PCM digital signal transmitted from the far-end is received by the 360/363 D4 terminal common equipment and routed to the 3658–02 via the RDATA lead. The DECODER and RCV FILTER then perform a Digital-To-Analog (D/A) conversion of the signal and suppression of frequencies that are outside the bandwidth of the standard voice frequency.

The output of the RCV FILTER is applied to the RCV GAIN and RCV ATTEN circuits which, acting together, set the receive path gain to the exact level required to interface with a range of office TLPs. The use of the RCV ATTEN allows finely controlled adjustment for the output level from $+4.5$ to -4.0 dBm.

4.3 Transmit Signaling

Ringling, loop-current, or tip-ground information is multiplexed onto the T1 line by the ENCODER.

A ground signal applied to the tip lead is detected by the RINGING AND TIP GROUND DETECTORS circuit. The 3658–02 will then transmit this tip-ground condition to the ENCODER where it will be multiplexed onto the A highway of the T1 line.

When the RINGING AND TIP GROUND DETECTORS circuit senses ringling on the T&R leads, this ringling condition will be multiplexed onto the B highway of the T1 line.

The RINGING AND TIP GROUND DETECTORS circuit senses an on-hook or off-hook condition by detecting the presence of loop current. This status is sent along the A highway.

4.4 Receive Signaling

In the receive direction, signaling information is sent through the DECODER from the T1 line and transmitted to the RG RELAY and the LC RELAY.

A ring-ground signal from the far-end is output by the DECODER, causing the RG RELAY to operate, thereby grounding the ring lead (pin 48).

A loop closure signal, sent along the A highway, is output from the DECODER into the LC RELAY. Closure of this relay completes the circuit on the loop side. The BUSY LED is illuminated when the LC RELAY is operated to indicate that the channel unit is busy.

4.5 Trunk Processing During a Carrier Group Alarm (CGA)

When a carrier failure occurs, the CGAI bus goes to ground, causing the LC RELAY to open and the RG RELAY to be disconnected. Approximately 2.5 seconds after a carrier failure, the RG or LC RELAYS can wink open and return to closure or just close, depending on how the CGA options (S7-1-6) are set.

5. MOUNTING

The 3658–02 mounts in one channel unit slot of a 360/363 D4 terminal. The 3658–02 is equipped with an insert/eject lever mechanism in the form of a hinged front panel. The mechanism ensures a positive connection between the channel unit’s card-edge connector and the backplane connector when the unit is installed. The insert/eject lever also facilitates removal of the unit.

CAUTION

Installation and removal of channel units should be done with care. Do not force a unit into place. If excessive resistance is encountered while installing a unit, remove it, and check the card guides and connector to verify proper alignment and the absence of foreign material.

Step	Action
9.	Align the channel unit with the appropriate card-guided slot of the terminal.
10.	Slide the unit into the slot with the front panel in a horizontal (up) position.
11.	When the top portion of the hinged front panel is under the front lip of the terminal, push down on the front panel until it is in the vertical position. The channel unit’s card-edge connector will begin to make contact with the inner portion of the backplane connector.
12.	Continue applying light pressure onto the bottom edge of the front panel until the unit snaps into place.

6. INSTALLER CONNECTIONS

Installer connections are made to the channel unit by wire-wrapping leads onto the associated 50-pin connectors located on the backplane assembly of the 360/363 D4 terminal. On connectorized 360/363 D4 terminals (360–10, –11, etc.), connections are made via 25-pair female connectors (CINCH 222–22–50–023 or equivalent) to the appropriate 25-pair male connectors of the 360/363 D4 terminal. Refer to Section 360-000-200 for the wiring diagrams of the female connectors with respect to the 360/363 D4 terminal being utilized. Electrical connections are made when the unit is installed.

7. OPTIONS

The following paragraphs describe the options that are used to condition the 3658–02 for proper application and operation. Refer to Table 2 for the option locations and a summary of the option functions.

7.1 Switch S1 – NORM/BUSY

Place switch S1 to the NORM (down) position to condition the 3658–02 for normal (in-service) operation. Place S1 to the BUSY (up) position to create an out-of-service condition for testing or alignment purposes. This will also light the BUSY LED on the front panel and on the Alarm Logic Unit (ALU), and will busy the channel unit on the far-end.

7.2 Switch S3 – XMT Prescription Attenuation

S3 is an eight-section DIP switch that selects the appropriate amount of attenuation between 0 and 8.5dB in 0.1dB increments for adjusting the transmit path to the proper operating level. By placing the individual switches of S3 (4, 2, 1, 0.8, 0.4, 0.2, 0.1dB) to the ON position as required, the desired level of +5.2dBm at the input to the ENCODER can be achieved.

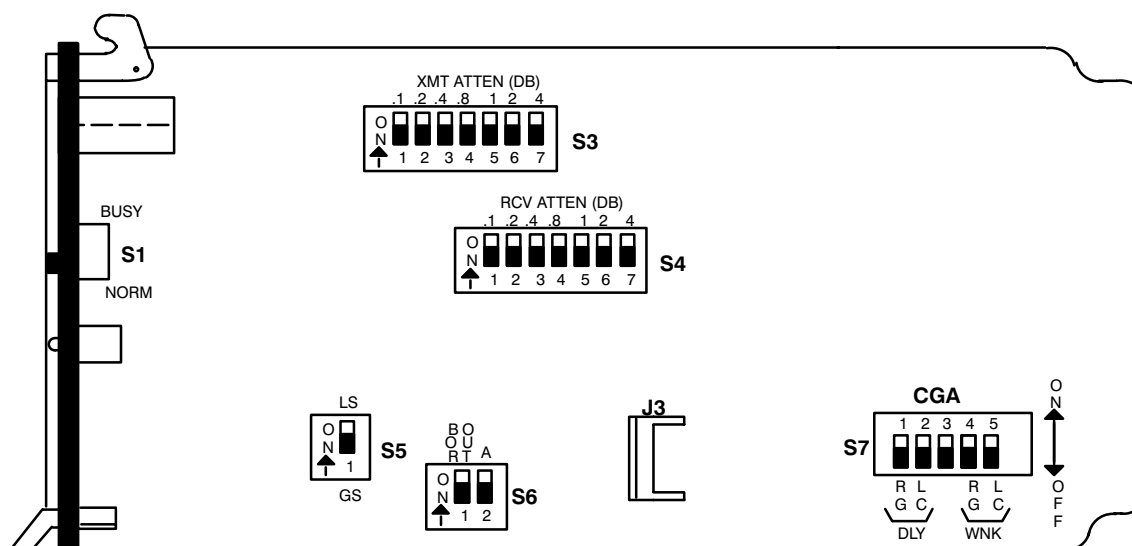

Figure 4. 3658–02 2W FXO Option Locations

Table 2. 3658–02 2W FXO Optioning Summary

Option	Position	Function
S1	NORM	For in-service operation.
	BUSY	For testing or alignment.
S2	—	Switch designation S2 not used on this module
S3	ON/OFF as required	7-section DIP switch selects transmit attenuation (XMT ATTN) between 0dB and 8.5db in 0.1dB increments
S4	ON/OFF as required	7-section DIP switch selects receive attenuation (RCV ATTN) between 0dB and 8.5db in 0.1dB increments
S5	LS	To select loop-start mode of operation.
	GS	To select ground-start mode of operation.
S6	S6–1 ON (A)	To select a compromise network resistance of 900 ohms plus 2.15 μ F capacitance.
	OFF	If an external Comp Net/PBN is used, or if Jack 3 is equipped.
S6	S6–2 ON(BOR out)	To remove on-board 400 ohms for loops greater than 1.1k ohms.
	OFF	To add on-board 400 ohms for shorter loops.
S7	S7–1 ON	To close RG RELAY during carrier failure.
	S7–2 ON	To close LC RELAY during carrier failure.
	S7–3	Not used
	S7–4 ON	To cause RG RELAY to wink during carrier failure.
	S7–5 ON	To cause LC RELAY to wink during carrier failure.
J3	See para 7.7	Jack for mounting optional COMP NET/PBN 3690–00/10, –01/11, –02/12, or –03/13.

7.3 Switch S4 – RCV Prescription Attenuation

S4 is a eight-section DIP switch that selects the appropriate amount of attenuation between 0 and 8.5dB in 0.1dB increments for adjusting the receive path to the proper operating level. By placing the individual switches of S4 (4, 2, 1, 0.8, 0.4, 0.2, 0.1dB) to the ON position as required, the output level at T&R can be varied to obtain the desired output level.

7.4 Switch S5 – Loop-Start/Ground-Start

The LS/GS option selects the proper mode of operation. To operate in the loop-start mode, place switch S5 in the LS position. To operate in the ground-start mode, place switch S5 in the GS position.

7.5 Switch S6–1, –2 Compromise Balance Network/Build-Out-Resistance

Switch S6-1 (A) is used to select a compromise balance network of 900-ohms in series with a 2.15 μ F capacitor. To select this option, set switch S2-1 to ON. If a PBN or other Comp Net is used (3690-type or external) set S6–1 to off.

Set S6–2 (BOR) to the ON position to short-out 400 ohms resistance for loops greater than 1.1k ohms. To reduce power dissipation, on shorter loops, set S6–2 to the OPEN position, adding in the 400 ohms for shorter loops.

7.6 CGA Switches S7-1 thru S7–7

Upon carrier failure, an immediate alarm (CGAI) opens the LC RELAY and disconnects the RG RELAY. Approximately 2.5 seconds later, when a Carrier Group Alarm Delay (CGAD) or Carrier Group Alarm Wink (CGAW) arrives, depending on how the CGA switches are set, the following occurs:

- With only S7-1 set to ON, RG RELAY closes
- With only S7-2 set to ON, LC RELAY closes
- With only S7-4 set to ON, RG RELAY winks
- With only S7-5 set to ON, LC RELAY winks

Note: Switches S7-1, -2 will override switches S7-4, -5 respectively.

7.7 Jack J3 – Comp Net/PBN, Hybrid Balancing

A Charles 3690–00/10, –01/11, –02/12, or –03/13 Subassembly can be ordered separately and inserted into jack J3 to provide hybrid balancing. Hybrid balance can also be provided by an external compromise network or PBN via leads PN1 (pin 46) and PN2 (pin 41). Additional information on the 3690–XX Subassemblies is available in Section 369–0XX–201.

8. ALIGNMENT

8.1 Transmit Alignment

The XMT ATTEN switch S3 is a prescription control that provides attenuation from 0 to 8.5dB in increments of 0.1dB to accommodate an input TLP range from –4.5 to +4.0dBm. To adjust the transmit path to the proper operating level, the difference between –4.5 and the transmit TLP at T&R must be obtained:

$$[\text{XMT ATTEN} = \text{TLP} - (-4.5)]$$

For an input TLP of –2.0dBm, the XMT ATTEN=(–2.0) – (–4.5)=2.5dB. Set the sum of the switches on S3 to 2.5.

8.2 Receive Alignment

The RCV ATTEN switch S4 is a prescription control that provides attenuation from 0 to 8.5dB in increments of 0.1dB to accommodate an output TLP range from –4.0 to +4.5dBm. To adjust the receive path to the proper operating level, the difference between 4.5 and the receive TLP at T&R must be obtained:

$$[\text{RCV ATTEN} = 4.5 - \text{TLP}]$$

For an output TLP of –4.0dBm, the RCV ATTEN=4.5 – (–4.0)=8.5dB. Set the sum of the switches on S4 to 8.5.

9. TESTING

After completing Parts 4 through 8, place a call end-to-end through the facility to verify proper operation. If trouble is encountered, recheck all installer connections, optioning, and alignment settings, and verify that the channel unit is making positive contact with the backplane connector. If the difficulty persists, replace the unit with one known to be good and retest the facility. Channel unit testing for fault diagnosis or verification of circuit operation is provided in Section 360–001–205.

10. TECHNICAL ASSISTANCE

If technical assistance is required, contact Charles Industries' Technical Services Center at:

847–806–8500
 847–806–8556 (FAX)
 800–607–8500
 techserv@charlesindustries.com (e-mail)

11. WARRANTY & CUSTOMER SERVICE

11.1 Warranty

Charles Industries, Ltd. offers an industry-leading, 5-year warranty on products manufactured by Charles Industries. Contact your local Sales Representative at the address or telephone numbers below for warranty details. The warranty provisions are subject to change without notice. The terms and conditions applicable to any specific sale of product shall be defined in the resulting sales contract.

Charles Industries, Ltd.
 5600 Apollo Drive
 Rolling Meadows, Illinois 60008–4049
 847–806–6300 (Main Office)
 847–806–6231 (FAX)

11.2 Field Repairs (In-Warranty Units)

Field repairs involving the replacement of components within a unit are not recommended and may void the warranty and compatibility with any applicable regulatory or agency requirements. If a unit needs repair, contact Charles Industries, Ltd. for replacement or repair instructions, or follow the *Repair Service Procedure* below.

11.3 Advanced Replacement Service (In-Warranty Units)

Charles Industries, Ltd. offers an “advanced replacement” service if a replacement unit is required as soon as possible. With this service, the unit will be shipped in the fastest manner consistent with the urgency of the situation. In most cases, there are no charges for in-warranty repairs, except for the transportation charges of the unit and for a testing and handling charge for units returned with no trouble found. Upon receipt of the advanced replacement unit, return the out-of-service unit in the carton in which the replacement was shipped, using the pre-addressed shipping label provided. Call your customer service representative at the telephone number above for more details.

11.4 Standard Repair and Replacement Service (Both In-Warranty and Out-Of-Warranty Units)

Charles Industries, Ltd. offers a standard repair or exchange service for units either in- or out-of-warranty. With this service, units may be shipped to Charles Industries for either repair and quality testing or exchanged for a replacement unit, as determined by Charles Industries. Follow the *Repair Service Procedure* below to return units and to secure a repair or replacement. A handling charge applies for equipment returned with no trouble found. To obtain more details of this service and a schedule of prices, contact the CI Service Center at 217–932–5288 (FAX 217–932–2943).

Repair Service Procedure

1. Prepare, complete, and enclose a purchase order in the box with the equipment to be returned.
2. Include the following information:
 - Company name and address
 - Contact name and phone number
 - Inventory of equipment being shipped
 - Particulars as to the nature of the failure
 - Return shipping address

3. Ship the equipment, purchase order, and above-listed information, transportation prepaid, to the service center address shown below.

 CI Service Center
 503 N.E. 15th St., P.O. Box 339
 Casey, IL 62420–2054
4. Most repaired or replaced units will be returned within 30 or 45 days, depending on the product type and availability of repair parts. Repaired units are warranted for either 90 days from the date of repair or for the remaining unexpired portion of the original warranty, whichever is longer.

12. SPECIFICATIONS

12.1 Transmission

- (a) 2-WIRE IMPEDANCE: 900 ohms
- (b) DROP-SIDE TRANSMIT AND RECEIVE LEVELS: –4.5dB (min), +4.0dB (max).
- (c) ADJUSTABLE TRANSMIT AND RECEIVE ATTENUATION: 0.0dB to 8.5dB in 0.1dB increments.
- (d) TRANSMIT AND RECEIVE PATH FREQUENCY RESPONSE (Referenced at 1kHz):

FREQUENCY (Hz)	XMT (dB)	RCV (dB)
60	–20 maximum	—
200	0 to –3	0 to –2
300	+0.25 to –0.5	+0.25 to –0.5
1000	0 (Reference)	0 (Reference)
3000	+0.25 to –0.5	+0.25 to –0.5
3200	+0.25 to –0.75	+0.25 to –0.75
3400	0 to –1.5	0 to –1.5
4000	–14 maximum	–14 maximum
4600	–32 maximum	–28 maximum

- (e) LONGITUDINAL BALANCE: 58dB minimum at 200Hz to 1kHz; 53dB minimum at 3kHz.
- (f) SIGNAL TO DISTORTION RATIO: 35dB minimum at 0 to –30dBm0; 29dB minimum at –40dBm0; 25dB minimum at –45dBm0.
- (g) TRANS-HYBRID LOSS: Echo, 34dB minimum; singing, 20dB minimum.
- (h) RETURN LOSS: Echo, 28dB minimum; singing, 20dB minimum.
- (i) TRANSMIT/RECEIVE IDLE CHANNEL NOISE: 20dBmC0 maximum.
- (j) LEVEL TRACKING (Measured Single-Ended at 1010Hz): ± 0.25 dB from +3 to –37dBm0; ± 0.5 dB from –38 to –50dBm0.

12.2 Power Requirements

- (a) OPERATING VOLTAGE RANGE: –44 to –56Vdc.
- (b) MAXIMUM CURRENT DRAIN (at –48Vdc): Idle, 25mA; busy, 40mA.
- (c) MINIMUM OPERATE CURRENT: 20mA.

12.3 Signaling

- (a) RING LEAD RESISTANCE TO GROUND: 410 ohms nominal.

- (b) TIP GROUND DETECTOR SENSITIVITY: 850 ohms must be detected; 10,000 ohms must not be detected.
- (c) RINGING SENSITIVITY: 65Vrms at 20Hz.
- (d) INTERNAL LOOP RESISTANCE: BOR in, 800 ohms; BOR out, 360 ohms.

12.4 Physical

See Table 3 for the physical characteristics of the unit.

Table 3. Physical Specifications

Feature	U.S.	Metric
Height	4.25 inches	10.8 centimeters
Width	1.31 inches	3.3 centimeters
Depth	10.31 inches	26.2 centimeters
Weight	16 ounces	454 grams
Temperature	32 to 122°F	0 to 50°C

