

7.5T KVA Isotransformer™

MARINE ISOLATION TRANSFORMER

INSTALLATION INSTRUCTIONS & OWNER'S MANUAL Model 93-IXFMR7/5T-A

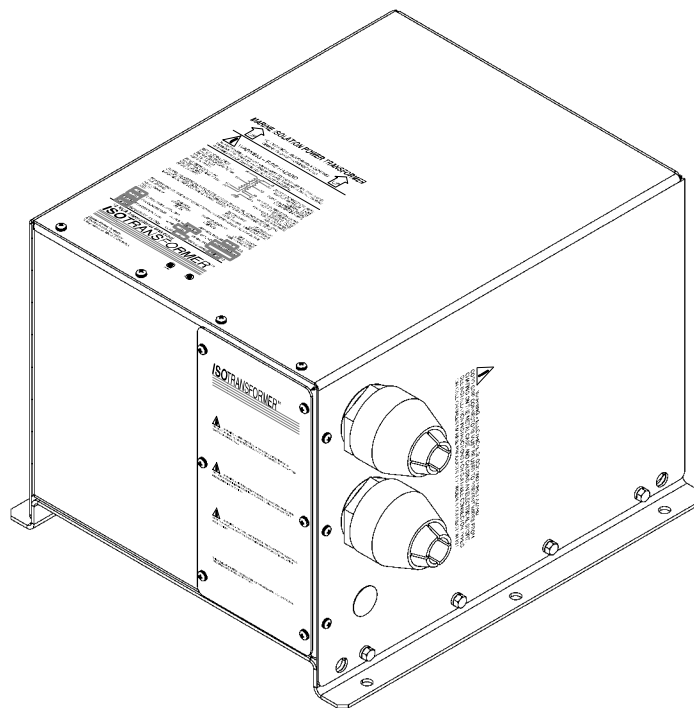

Contents

INTRODUCING... THE 7.5T KVA ISOTRANSFORMER	3
Manual Purpose	3
APPLICATION	3
IMPORTANT SAFETY INSTRUCTIONS	3
Warnings	3
Installation Precaution	4
Environmental Precaution	4
Application Precaution	4
Damaged Unit Precaution	4
Disassembly Precaution	4
INSTALLING THE ISOTRANSFORMER	5
Choosing an Electrical Wiring Method	5
Wired as an Isolation Transformer	5
Wired as a Polarization Transformer	8
Choosing Mounting Location	9
Choosing Mounting Hardware	10
Mounting the IsoTransformer	10
Choosing the Appropriate Wire Type and Gauge	10
Choosing Electrical Wiring Hardware	11
Overcurrent Protection	11
Making IsoTransformer Connections	12
Securing Covers	12
Applying Power	12
OPERATING THE ISOTRANSFORMER	14
Safety First	14
Proper Operation	14
MAINTAINING THE ISOTRANSFORMER	14
TROUBLESHOOTING	14
WARRANTY & CUSTOMER SERVICE	15
Warranty	15
Service Center and Repair Correspondence	15
SPECIFICATIONS	15
PRODUCT LABELING	16

INTRODUCING... THE 7.5T KVA ISOTRANSFORMER™

Thank you for purchasing the 7.5T KVA IsoTransformer™! Your IsoTransformer completely isolates input power from output power, providing an improved degree of safety and reducing galvanic current corrosion.

Manual Purpose

With your personal safety in mind, this manual lists important safety precautions first, then covers installation, operation, maintenance, troubleshooting, warranty, and customer service information.

APPLICATION

The 7.5T KVA IsoTransformer is a shoreline isolation transformer intended for boats with 30 amp/240 volt service. Properly installed, it will electrically isolate AC shore power from the boat's AC power system, reducing galvanic current corrosion due to the AC shore power connection.

The boat's electrical system and grounding conductor are not actually connected to the shoreside system when you use the 7.5T KVA IsoTransformer as an isolation transformer. Power is transferred from the shoreside electrical system to the boat's electrical system by magnetic coupling. This means there is no direct electrical connection between the earth-grounded shore AC power and boat AC power systems. The shore grounding conductor is connected to a shield that is wound between the primary (shore) and secondary (boat) transformer windings. This shield assures isolation on the boat by providing a protective layer between primary and secondary windings within the transformer. In the unlikely event of a breakdown within the transformer, the shield can withstand the fault current of a properly sized shore supply circuit breaker long enough for the breaker to trip. In addition, by grounding one leg of the transformer secondary (L2) on board the boat, a "neutral" ground is established for the vessel's electrical system. When using the transformer, shoreline polarity is no longer a consideration and a shoreline polarity device is not necessary.

IMPORTANT SAFETY INSTRUCTIONS

SAVE THESE INSTRUCTIONS. This manual contains important safety and operating instructions for the IsoTransformer. Read the entire manual before usage. Also read all instructions and cautions for and on the IsoTransformer.

Warnings

WARNING — HIGH VOLTAGE

To avoid serious injury or death from high voltage electrical shock disconnect, AC shore power before opening panel.

WARNING — FIRE HAZARD

Primary and secondary overcurrent protection and conductor sizing must be in accordance with manufacturer's installation instructions.

WARNING

On board and in-water shock hazard. Transformer must be connected in accordance with manufacturer's installation instructions.

WARNING — FIRE HAZARD

Do not store equipment on or next to transformer. This unit is designed to operate hot and must have free air flow to prevent overheating or charring of adjacent material.

WARNING — ELECTRICAL SHOCK AND FIRE HAZARD

Cord grip connectors must be used to prevent wires from chafing on the metal case and causing an electrical short. See installation instructions for suitable connector types or call Charles Marine Products to order a connector kit.

Installation Precaution

Boat wiring is a complex task that can cause shock, corrosion and other hazards if not done properly by trained, experienced personnel. For more information on this subject contact the **American Boat and Yacht Council (ABYC)** or see the standards and regulations below:

**American Boat and Yacht Council
E-11 “AC and DC Electrical Systems on Boats”**

3069 Solomon’s Island Road
Edgewater, MD 21037
Telephone: 410.956.1050
FAX: 410.456.2737

**NFPA Standard 302.
“Pleasure and Commercial Motor Craft”**

National Fire Protection Association
1 Batterymarch Park
P.O. Box 9101
Quincy, MA 02269–9401
Telephone: 800.344.3555

Rules and Regulations for Recreational Boats

Excerpts from the United States Code (USC) and the Code of Federal Regulations (CFR) (U.S. Coast Guard Regulations) are available from the **American Boat and Yacht Council** listed above.

Note: Installation of the IsoTransformer must be made in accordance with all applicable standards and regulations.

Environmental Precaution

The IsoTransformer is intended for installation inside an engine room or elsewhere inside the boat. Make sure that the location will not subject the unit to rain, snow, excessive moisture, or excessive heat.

NOTICE

This device is ignition-protected in accordance with U.S. Coast Guard regulations under 33 CFR 183.410.

Application Precaution

These units are intended for hard-wired, permanent, on-board applications. Use of attachments not recommended or sold by Charles Marine Products may result in risk of fire, electrical shock or personal injury.

Damaged Unit Precaution

Do not operate the IsoTransformer if it has received a sharp blow, been dropped, immersed in water or otherwise damaged. See the section in this manual on *Warranty & Customer Service* for repair information.

Disassembly Precaution

Do not disassemble the IsoTransformer. See the sections in this manual on *Maintaining the IsoTransformer*, *Troubleshooting the IsoTransformer* and *Warranty & Customer Service*.

INSTALLING THE ISOTRANSFORMER

Choosing an Electrical Wiring Method

There are two wiring methods that can be used to install the IsoTransformer as an isolation transformer in accordance with *ABYC E-11 AC and DC Electrical Systems on Boats*. A third method, also in accordance with *ABYC E-11*, can be used to install the IsoTransformer as a polarization transformer if desired. The third method is not preferred, because wiring the unit in the manner described circumvents the AC grounding conductor isolation between shore and boat power and may require the use of a galvanic isolator to reduce galvanic corrosion.

Note: Figure 1, Figure 2 and Figure 3 are reprinted with permission from the American Boat and Yacht Council (ABYC). To obtain the complete standard referenced or any other standards contact:

*American Boat and Yacht Council: 3069 Solomon's Island Road
Edgewater, MD 21037
Telephone: 410.956.1050
FAX: 410.456.2737*

Wired as an Isolation Transformer

The only difference between the two methods below is that in Method 2, a Ground Fault Protector (GFP) must be used instead of just a circuit breaker, and the shore grounding conductor is not wired past the inlet of the boat. Method 1 is most commonly used.

Note: This diagram does not illustrate a complete system. Refer to the appropriate ABYC text.

Isolation Transformer System with Single-Phase 240-Volt Input, 120/240-Volt Single-Phase Output with Boat Grounded Secondary. Shield Grounded on Shore and Metal Case Grounded on Boat. The Ungrounded shore current-carrying conductors are connected from the power inlet to the primary winding of the isolation transformer through an overcurrent protection device which simultaneously opens both current carrying conductors. Do not connect the shore neutral. Fuses shall not be used in lieu of simultaneous trip devices.

240-Volt branch circuit breakers and switches simultaneously open all current-carrying conductors.

120-Volt branch circuit breakers are permitted to use single-pole breakers in the ungrounded current-carrying conductors.

Polarization of conductors must be observed in all circuits.

The green grounding wire from the shore is connected to the shore power inlet shell which is insulated from metal-hulled boats. Do not connect the shore green wire to the boat ground.

The grounded neutral from the secondary of the isolation transformer and the case of the transformer are connected to the system ground, neutral conductor and engine negative terminal or its bus.

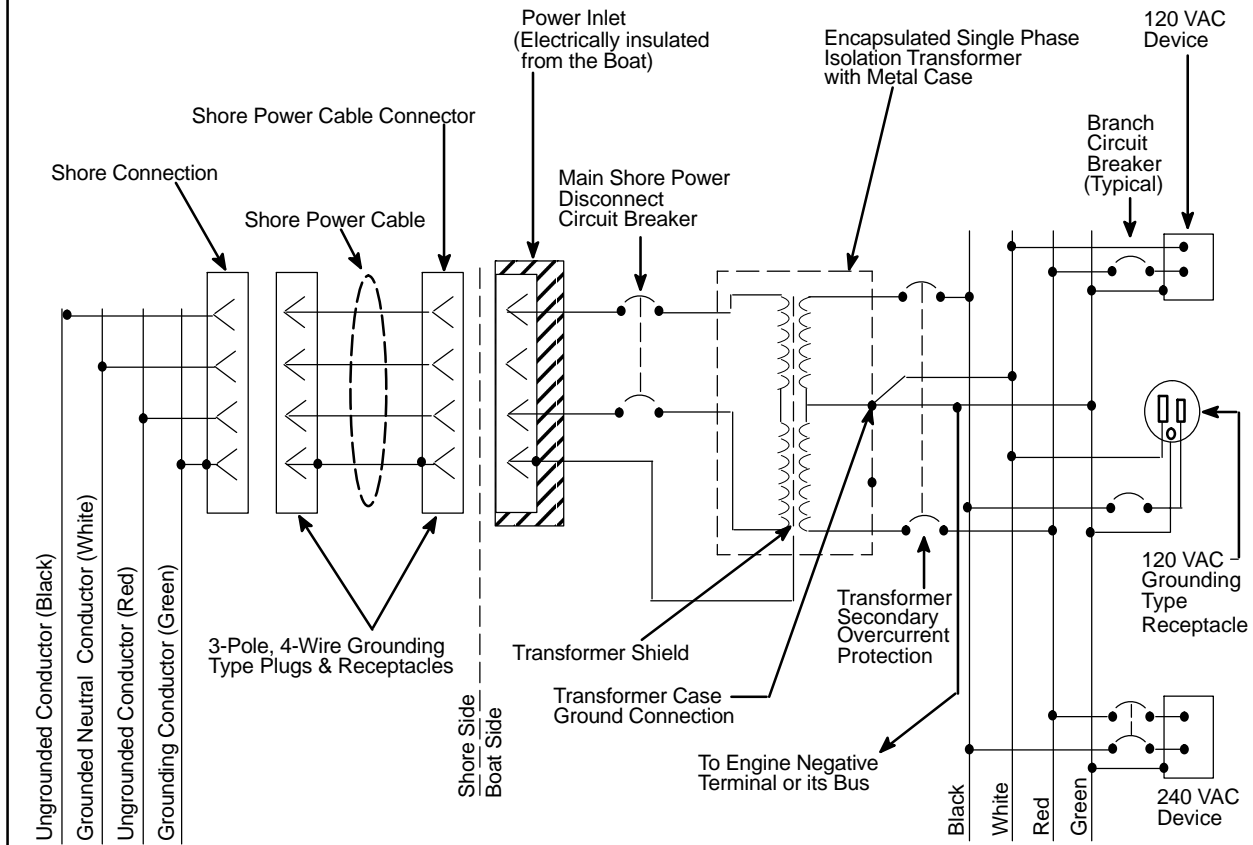

Figure 1. Electrical Diagram – Method 1 (see Figure 5 for Wiring Connections)

Note: This diagram does not illustrate a complete system. Refer to the appropriate ABYC text.

Isolation Transformer System with Single-Phase 240-Volt Input, 120/240-Volt Single-Phase Output, Ground Fault Protection and a Grounded Secondary. Shield and Metal Case Grounded on Boat. The ungrounded shore current-carrying conductors are connected from the power inlet to the primary winding of the isolation transformer through a ground fault protection device which simultaneously opens both current-carrying shore conductors. Fuses shall not be used in lieu of simultaneous trip devices.

240-Volt branch circuit breakers and switches simultaneously open all current-carrying conductors.

120-Volt branch circuit breakers are permitted to use single-pole breakers in the ungrounded current-carrying conductors.

Polarization of conductors must be observed in all circuits.

The green grounding wire from the shore power inlet is not connected to the Isolation transformer shield or case nor to the boat ground.

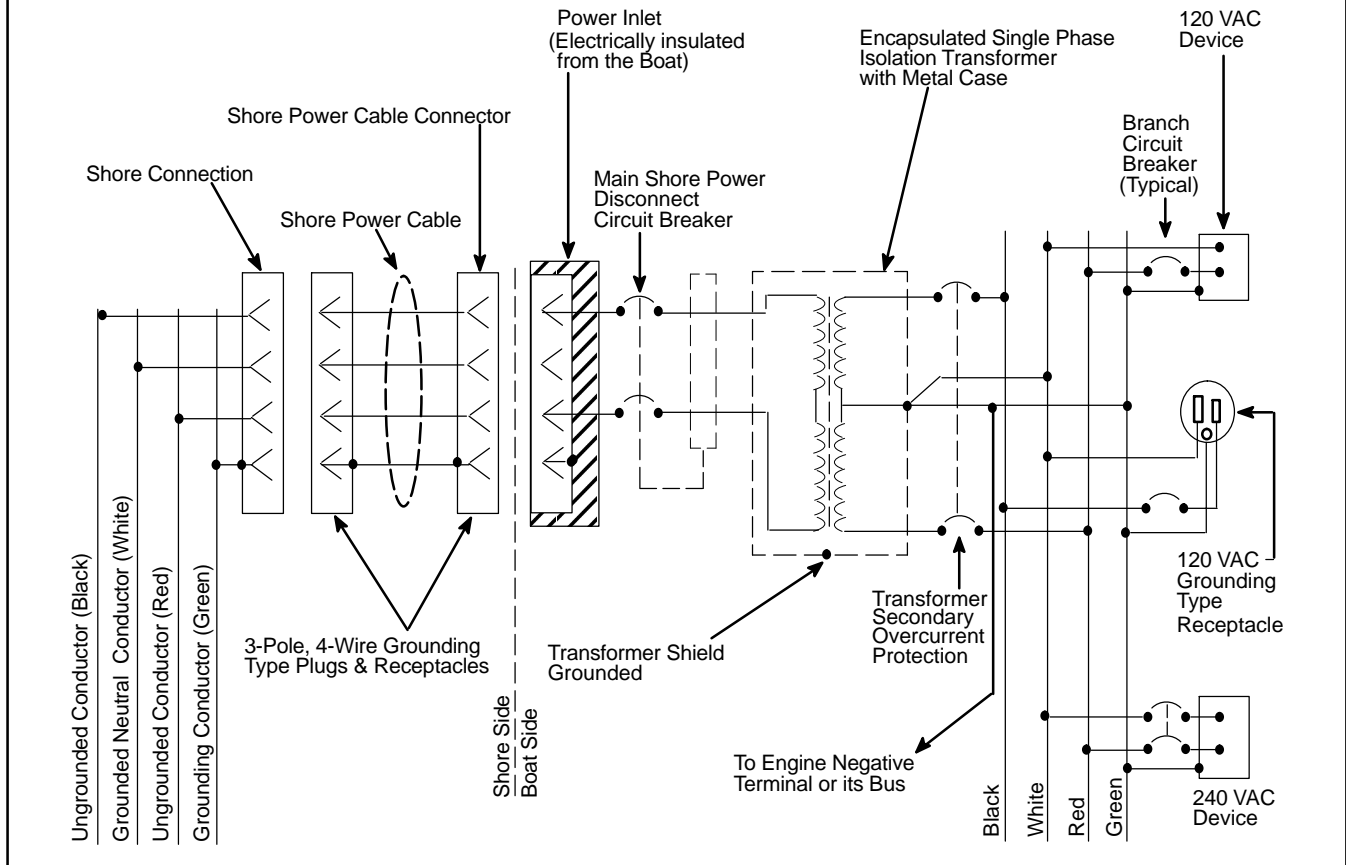

Figure 2. Electrical Diagram – Method 2 (see Figure 6 for Wiring Connections)

Wired as a Polarization Transformer

In this method the shield and the shore grounding conductor are wired directly to the transformer neutral (X2) and case ground (GND). An optional galvanic isolator is also shown in-line with the shoreline grounding wire.

Note: This diagram does not illustrate a complete system. Refer to the appropriate ABYC text.

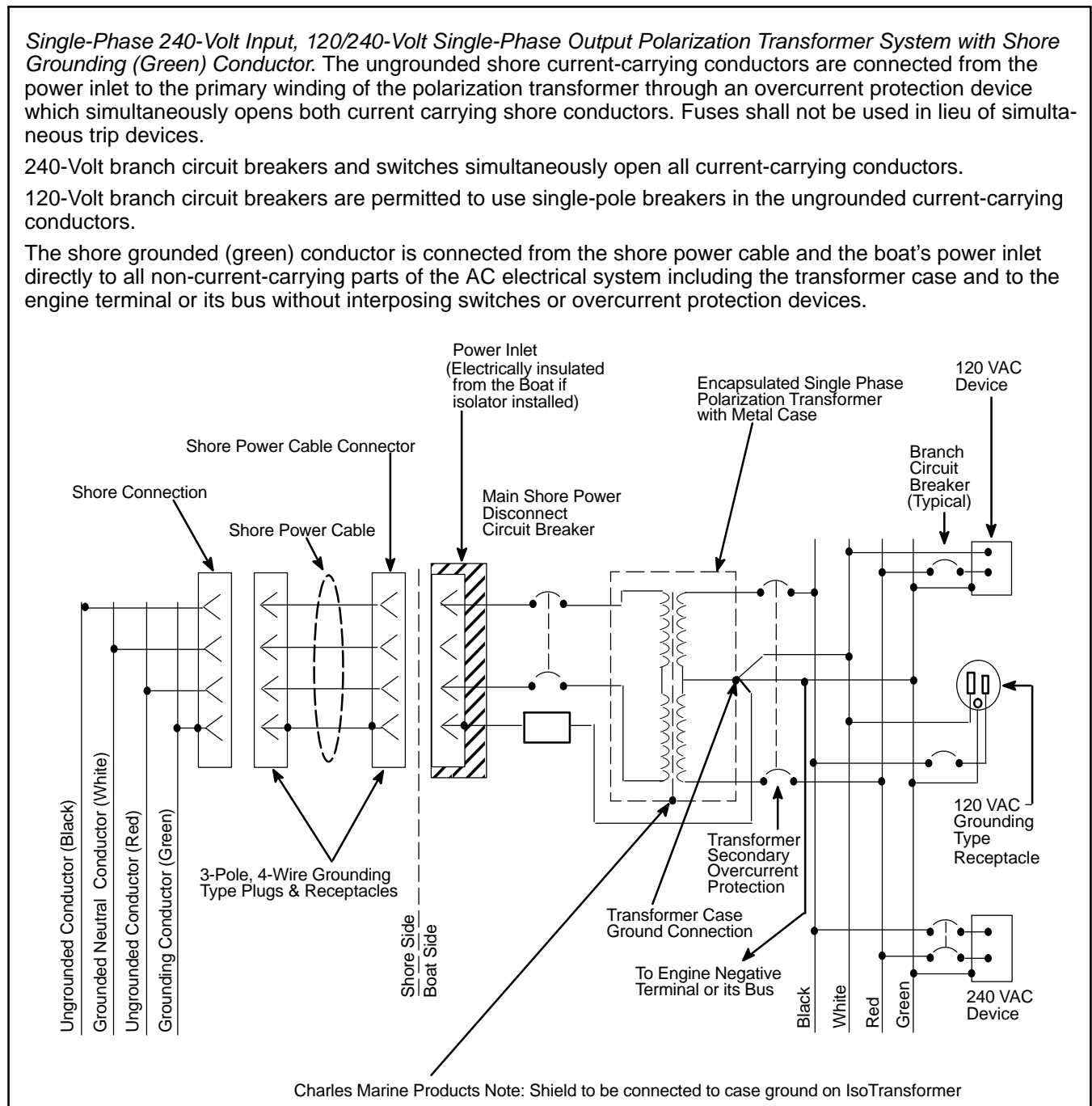

Figure 3. Electrical Diagram – Method 1 (see Figure 7 for Wiring Connections)

Choosing Mounting Location

After selecting a wiring method, the mounting location must be chosen. Like any piece of transformer operated equipment, the IsoTransformer will produce a noticeable “hum” when it is energized, although not nearly as loud as non-encapsulated transformers. Consideration should be given to not mounting the IsoTransformer in or immediately adjacent to areas where you will prefer quiet, such as sleeping quarters. Locations to avoid are under bunks or on the opposite side of an uninsulated bulkhead immediately adjacent to the head of a bunk. The IsoTransformer should be mounted either vertically on a bulkhead with the access panel at the bottom or horizontally on the deck in a protected area away from rain or spray. When mounted vertically the bottom must be at least 24 inches above the deck or other equipment to avoid damage from splash and to ensure adequate access to wiring connections. The unit must be mounted in a secure location capable of supporting the full weight of approximately 157 pounds. Proper ventilation around the case is important. Allow at least six inches on all four sides of the unit for air circulation and cooling. During normal operation the case of the IsoTransformer may reach high temperatures. To avoid burns locate the IsoTransformer in an area where persons will not come in contact with the unit.

Four 1/2-inch holes, 1 inch from each end of the IsoTransformer, have been provided for rigging and hoisting the unit. Typically, shackles are used for hoisting.

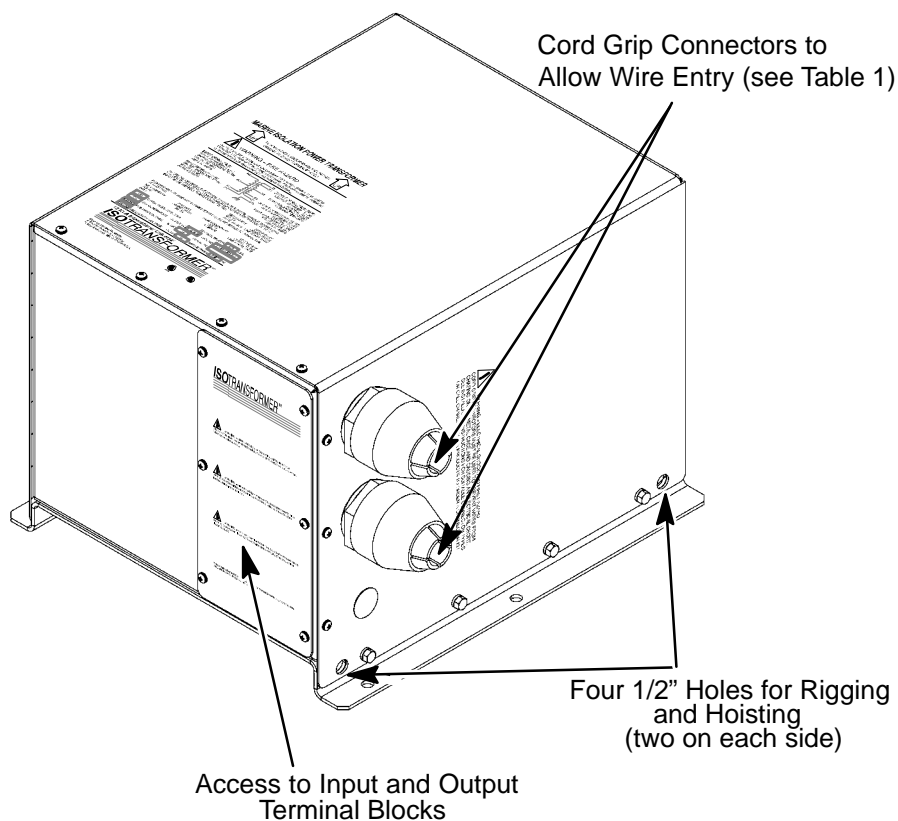

Figure 4. IsoTransformer Access Openings

WARNING – FIRE HAZARD

Do not store equipment on or next to transformer. This unit is designed to operate hot and must have free air flow to prevent overheating or charring of adjacent materials.

Choosing Mounting Hardware

As with any marine equipment, secure mounting is of utmost importance. You will need to provide six bolts or screws to secure the unit. They must be 3/8 inch in diameter. The screws or bolts you choose should be backed with a flat washer and kept vibration free with a split-ring lock washer. If using bolts, they must be secured on both sides of the bulkhead and also backed with a washer or washer plate. If using screws, they should be at least 1 inch long. All hardware must be corrosion-resistant stainless steel or cadmium-plated steel.

Mounting the IsoTransformer

The IsoTransformer may be mounted horizontally on a deck or vertically on a bulkhead.

CAUTION

Use appropriate equipment to hoist and rig unit. Care should be taken to ensure safety of individuals.

Horizontal Mount

Step	Action
1.	Carefully lower and position the IsoTransformer on the deck in the exact location the unit will be installed. <i>Note: The wiring enclosure should be visible and accessible.</i>
2.	Remove the IsoTransformer and drill six marked holes with the proper-sized drill bit.
3.	Re-align the IsoTransformer's mounting holes with the drilled holes and fasten the unit to the deck with the appropriate mounting hardware.
4.	Firmly secure all mounting hardware.

WARNING – ELECTRICAL SHOCK HAZARD

Use care when drilling to avoid contact with any wires or live components.

Vertical Mount

Step	Action
1.	Carefully lower and position the IsoTransformer on the bulkhead in the exact location the unit will be installed. <i>Note: The wiring compartment should be at the bottom to ensure proper cooling of the unit.</i>
2.	Remove the IsoTransformer and drill six marked holes with the proper-sized drill bit.
3.	Re-align the IsoTransformer's mounting holes with the drilled holes and fasten the unit to the bulkhead with the appropriate mounting hardware.
4.	Firmly secure all mounting hardware.

WARNING – ELECTRICAL SHOCK HAZARD

Use care when drilling to avoid contact with any wires or live components.

Choosing the Appropriate Wire Type and Gauge

All input and output conductors should be at least 6 AWG, stranded, 600 volt rating, UL type AWM, UL 1426 or equivalent, or a UL listed marine shore power cable. See ABYC standard E-8 for more details on conductor types and sizing (gauge).

Choosing Electrical Wiring Hardware

The usual application for the IsoTransformer is as an isolation transformer. In this application, there is no fault current path for the wiring from the shore power inlet to the IsoTransformer input connections. For this reason, the wiring should only be done with a jacketed cable (.030 inches jacket thickness minimum) such as UL type 1426 boat cable or by using a UL listed marine cable set wire (type SO or equivalent). This wiring should be installed in the boat in a protected area and routed to avoid contact with sharp edges or hot surfaces.

The IsoTransformer is intended for hard-wiring in a permanent location. Cord grip connectors with water sealing bushings and strain relief are required to secure wires or cables going into or out of the IsoTransformer.

WARNING – ELECTRICAL SHOCK HAZARD AND FIRE HAZARD

Cord grip connectors must be used to prevent wires from chafing on the metal case and causing an electrical short. See installation instructions for suitable connector types or call Charles Marine Products to order a connector kit.

Table 1 lists the parts approved by Charles Marine Products for use with the IsoTransformer.

Charles Industries recommends cord grip connector kit #97-001119-A.

Table 1. Recommended Cord Grip Connectors and Accessories

Description*	Cord Type	Manufacturer	Catalog Number	Sealing Washer	Locknut
Cord Range .472-.787	6/3 Boat Cable	Heyco	8443	3263	LN 1-1/4
Cord Range .510-.790	6/3 Boat Cable	Remke	RD29LR	SOR-4	LN 125
Cord Range .709-1.000	6/4 Boat Cable	Heyco	8441	3263	LN 1-1/4
Cord Range .700-.980	6/4 Boat Cable	Remke	RD29LA	SOR-4	LN 125
Cord Range .890-1.090	6/4 Boat Cable or 6/3 Cordset	Thomas & Betts	2702	5265	144
Cord Range 1.080-1.280	6/4 Cordset	Thomas & Betts	2703	5265	144

*All connectors have a 1 1/4-inches hub size and are straight connectors

Overcurrent Protection

Overcurrent protection must be provided at the time of installation by circuit breakers on both the primary (shore) and secondary (boat) circuits. A two-pole circuit breaker is required for both the shore power line going into the IsoTransformer and the output line going to the boat's AC electrical system. These should be rated at 30 amps, 240 volts, 5000 Ampere Interrupting Capacity (AIC) and be of the long time delay type.

A ground fault protector (GFP) is necessary if a shore grounding conductor is not used. This should be rated at 20 milliamperes or less and if combined with the primary (shoreline) circuit breaker, should be rated at 30 amps, 240 volts, 5000 AIC and be of the long-time delay type.

Making IsoTransformer Connections

WARNING – HIGH VOLTAGE

To avoid serious injury or death from high voltage electrical shock disconnect AC shore power before opening panel.

The wiring installation will depend on the method chosen in the section titled *Choosing an Electrical Wiring Method*. Follow the procedure below to make the appropriate connections.

Step	Action
1.	Remove the access cover.
2.	Install the cord grip connectors using the sealing gaskets and locknuts.
3.	Undo the chucks from the cord grip connectors.
4.	Slide the cord grip connectors down and over the cables from the primary (shore power) circuit breakers and to the secondary (boat) circuits.
5.	Insert the cables through the cord grip connectors and cut to length.
6.	Strip back the insulation.
7.	Crimp ring or captive spade terminals on all wires using an appropriate tool.
8.	<p>Connect all wiring as shown in Figure 5, Figure 6, or Figure 7 based on the chosen wiring method as follows:</p> <p>L1 and L2 (both input and output) Use UL recognized #6 AWG insulated butt connectors for making all L1 and L2 connections. Crimp and tape each connection individually with UL recognized electrical tape.</p> <p>GND and N (neutral) Use UL recognized ring or captive spade terminals for making the GND and N connections at the GND screw.</p> <p>SH When wiring as an isolation transformer, use a UL recognized insulated #4 AWG butt connector for the SH (shield) connection. Crimp and tape the connection. When wiring as an isolation transformer with primary ground fault protection or as a polarization transformer, use a UL recognized ring or captive spade terminal for making the SH (shield) connection at the GND screw.</p>
9.	Tighten the cord grip connectors.
10.	Re-install the terminal access cover.

Securing Covers

After all connections and terminations have been made, the terminal access cover should be re-installed using all hardware supplied.

Applying Power

Power should only be applied after all connections and terminations have been made and the terminal access cover is secure. Plug in the shore power and turn on the appropriate circuit breakers to apply power. Refer to the section on *Proper Operation*.

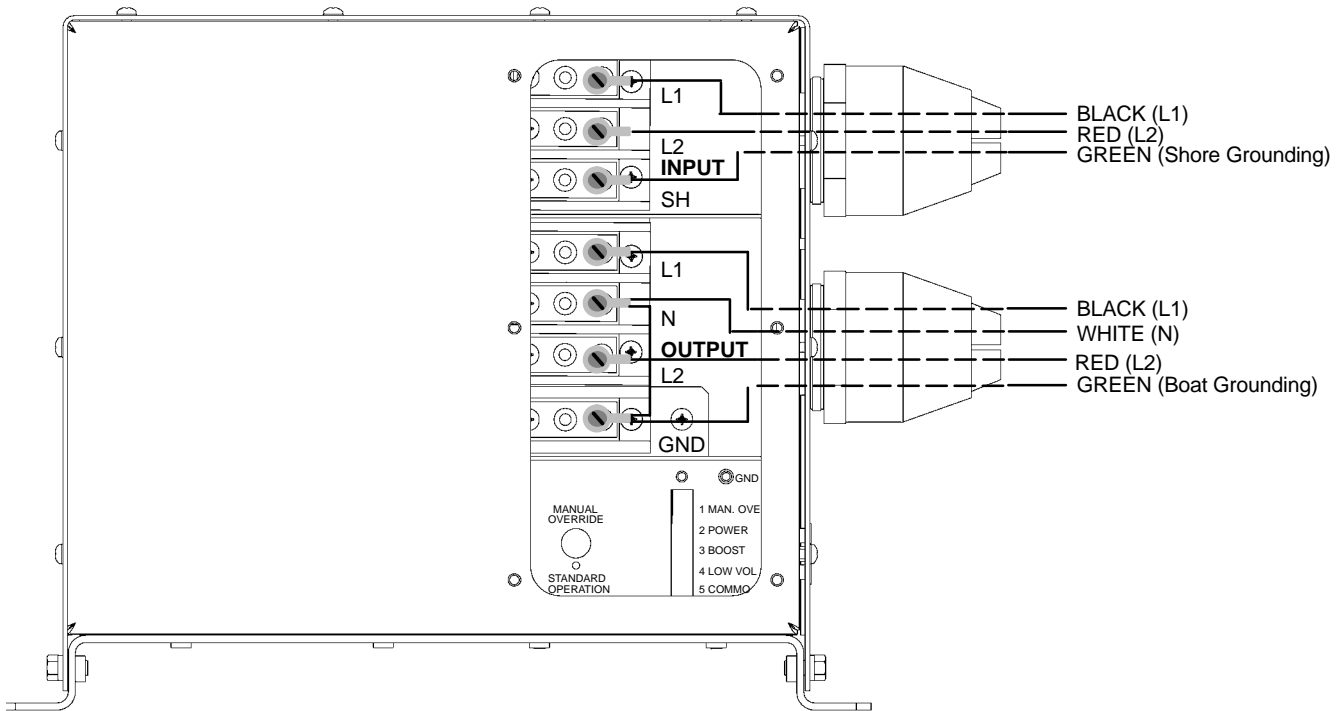

Figure 5. Typical Wiring as an Isolation Transformer – Method 1 (see Figure 1 for Electrical Diagram)

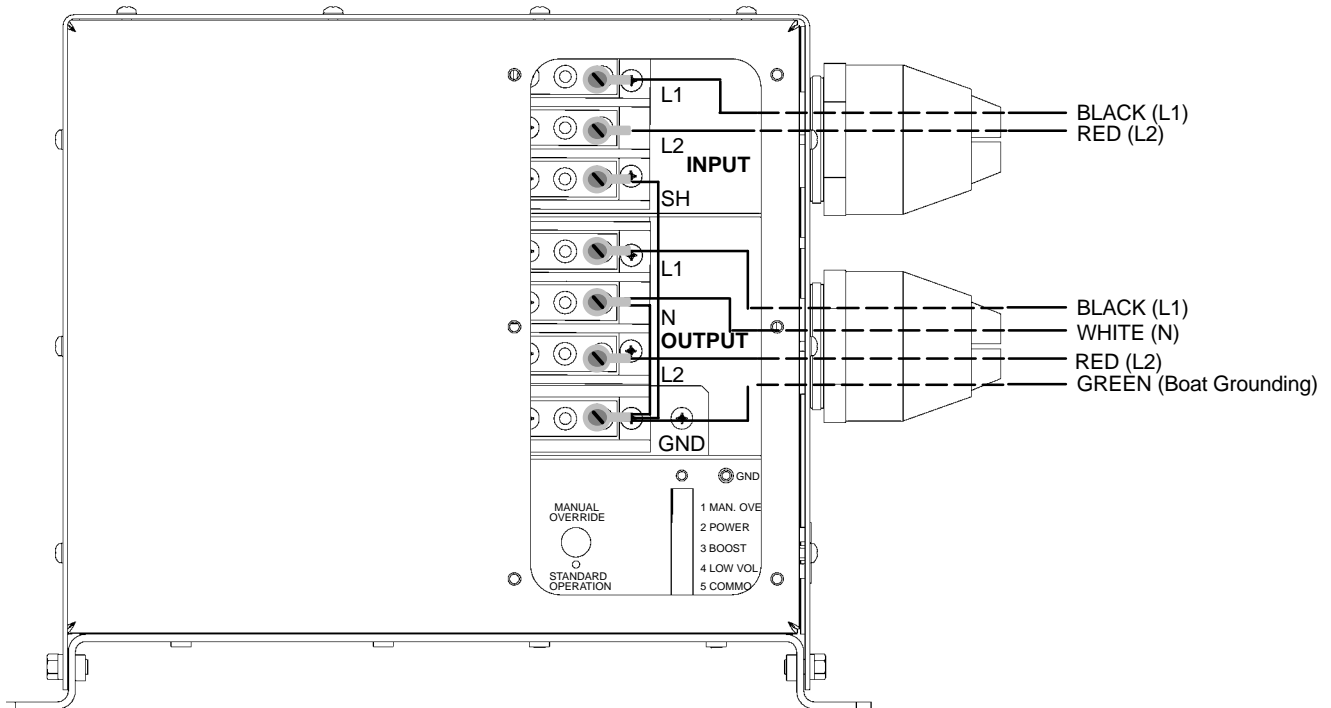

Figure 6. Typical Wiring as an Isolation Transformer with Primary Ground Fault Protector – Method 2 (see Figure 2 for Electrical Diagram)

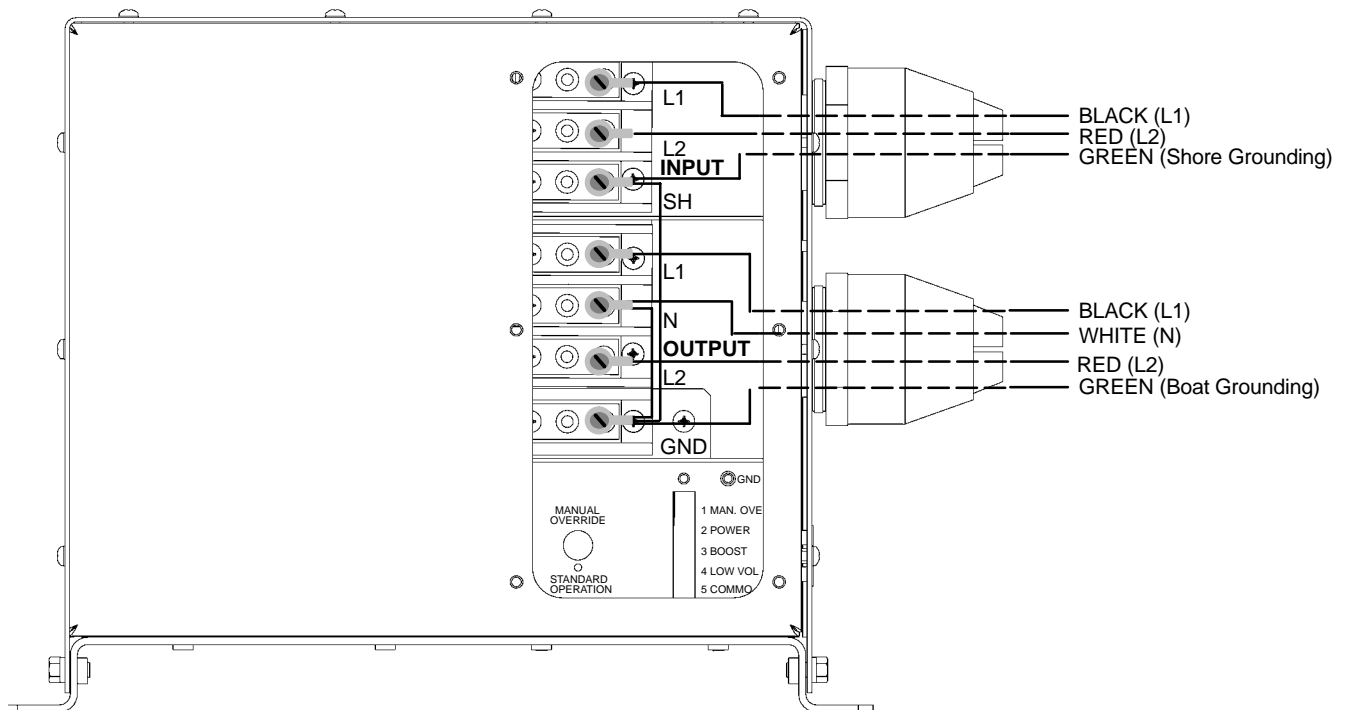

Figure 7. Typical Wiring as a Polarization Transformer – Method 1 (see Figure 3 for Electrical Diagram)

OPERATING THE ISOTRANSFORMER

Safety First

Follow all precautions in the *IMPORTANT SAFETY INSTRUCTIONS* section in this manual. Pay close attention to the DANGER, WARNING and CAUTION boxes both within this manual and labeled on the unit.

Proper Operation

When properly installed and connected, the IsoTransformer will provide isolation between shore and boat power while maintaining a one to one turns ratio (shore voltage equals boat voltage).

MAINTAINING THE ISOTRANSFORMER

WARNING – HIGH VOLTAGE

To avoid serious injury or death from high voltage electrical shock, disconnect the AC shore power before attempting any maintenance or cleaning.

No adjustment or maintenance is required for the IsoTransformer other than periodic cleaning of the outside cabinet with a dry cloth and inspecting all connections for tightness and corrosion by a qualified service person.

TROUBLESHOOTING

If there is a problem with the IsoTransformer, first check that all connections are accurate and secure, and retest. If all connections are good, contact Charles Marine Products for technical assistance.

WARRANTY & CUSTOMER SERVICE

Warranty

The CHARLES Marine & Industrial Group warrants the unit will be free from defects in materials and workmanship that cause mechanical failure for one (1) year, as set forth in the Limited Warranty. Notice of any alleged defect in material or workmanship must be provided within thirty (30) days of discovering the problem, and within the warranty period. Follow the procedure outlined below to obtain warranty service.

Service Center and Repair Correspondence

Note: Do not attempt to service the unit. Contact the Service Center.

To contact the Service Center via telephone directly:

800-830-6523 (Toll Free)

217-932-2317 (Voice)

217-932-2473 (FAX)

Call to obtain a Returned Materials Authorization (RMA) number prior to returning any unit to Charles Industries.

Return the unit for repairs to the Service & Repair Center address below:

Charles Industries, Ltd.
Marine & Industrial Group
503 NE 15th Street
Casey, IL 62420-2054
USA

Correspondence can be sent to Corporate Headquarters via the address below:

Note: Do not return the unit to this address.

Charles Industries, Ltd.
Marine & Industrial Group
5600 Apollo Drive
Rolling Meadows, IL 60008-4049
USA
847-806-6300
www.charlesindustries.com

SPECIFICATIONS

The specifications for the IsoTransformer are listed in Table 2.

Table 2. IsoTransformer Specifications

Feature	Specification
Input Voltage	240 VAC
Input Current	30 Amps
Output Voltage	120/240 VAC
Output Current	30 Amps
KVA Continuous	12.0 KVA
Operating Frequency	50/60 Hz
°C Rise Insulation System 220A	120° C

Feature	Specification
Insulation Class	H
% Impedance	3.00
Operating Temperature	0° to 50° C
Approximate Weight	157 pounds
Height	10.75 inches
Width	12.75 inches
Width (excluding the mounting flange)	10.65 inches
Depth	12.75 inches

PRODUCT LABELING

The 7.5T KVA International Universal IsoTransformer is labeled as shown in Figure 8. The product label contains information unique to the purchased unit.

MARINE ISOLATION POWER TRANSFORMER



UP

FOR VERTICAL (BULKHEAD) MOUNTING
ORIENT IN DIRECTION INDICATED



UP

38-100127-0-B



WARNING - FIRE HAZARD

DO NOT STORE EQUIPMENT ON OR NEXT TO TRANSFORMER. THIS UNIT IS DESIGNED TO OPERATE HOT AND MUST HAVE FREE AIR FLOW TO PREVENT OVERHEATING OR CHARRING OF ADJACENT MATERIAL.

INPUT CONNECTION

INPUT BETWEEN H1 - H2
SHORE GROUNDING TO SH
VOLTS 220 VAC
AMPS 34 AMPS

OUTPUT CONNECTION

OUTPUT BETWEEN X1-X2-X3
BOAT GROUNDING TO GND
VOLTS 110/220 VAC
AMPS 34 AMPS

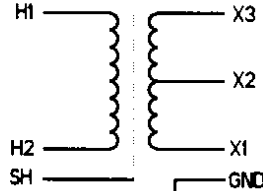

120 °C RISE INSUL. SYS. 220A

7.5 KVA CONTINUOUS

220 HIGH VOLTAGE CLASS

110/220 LOW VOLTAGE

APPROX. WEIGHT 157 LBS.

% IMP. 3.0

CLASS H

UL FILE NO. E183633

CAT. NO. 934XFMR7/5T

SERIAL NO. []

SINGLE PHASE 60 HZ

7.5 KVA

ISOTRANSFORMER™

Charles Marine Products
A Charles Industries Company
Rolling Meadows, Illinois 60008 U.S.A.







Figure 8. 7.5T KVA International Universal IsoTransformer Product Specification Label

