

3.8 KVA IsoGuard™

SHORELINE ISOLATION TRANSFORMER

INSTALLATION INSTRUCTIONS & OWNER'S MANUAL Model 93-IXFMR3/8NI-A

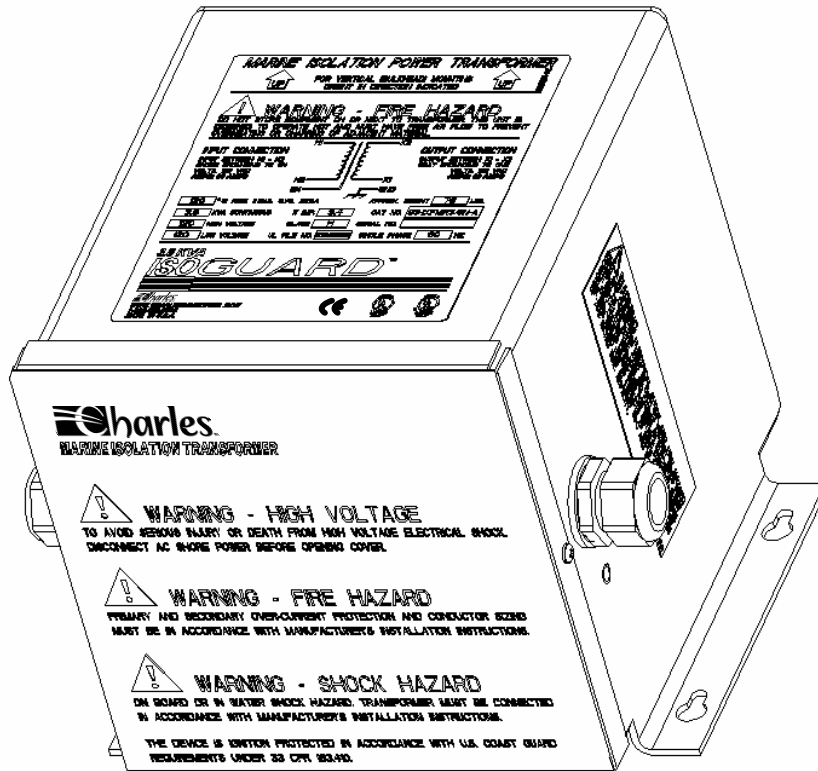

Contents

INTRODUCING... THE 3.8 KVA ISO GUARD™	3
Manual Purpose	3
APPLICATION	3
IMPORTANT SAFETY INSTRUCTIONS	3
Warnings	3
Installation Precaution	4
Environmental Precaution	4
Application Precaution	4
Damaged Unit Precaution	4
Disassembly Precaution	4
INSTALLING THE ISO GUARD	5
Ratings and Connections	5
Choosing an Electrical Wiring Method	5
Wired as an Isolation Transformer	6
Securing Covers	11
Applying Power	12
OPERATING THE ISO GUARD	12
Safety First	12
Proper Operation	12
MAINTAINING THE ISO GUARD	12
TROUBLESHOOTING	12
WARRANTY & CUSTOMER SERVICE	12
Warranty	12
Service Center and Repair Correspondence	12
SPECIFICATIONS	13

INTRODUCING... THE 3.8 ISOGUARD™

Thank you for purchasing the IsoGuard™! Your IsoGuard completely isolates input power from output power providing an improved degree of safety and reducing galvanic current corrosion due to the direct connection to AC shore power.

Manual Purpose

With your personal safety in mind, this manual lists important safety precautions first, then covers installation, operation, maintenance, troubleshooting, warranty, and customer service information.

APPLICATION

The 3.8 KVA IsoGuard is a shoreline isolation transformer intended for boats with 30 amp/120 volt or 16 amp/240 volt service. The unit will operate on either 50 or 60 Hz and provides easy adaptation to European electrical systems. Properly installed, the IsoTransformer will electrically isolate AC shore power from the boat's AC power system, reducing galvanic current corrosion due to the AC shore power connection.

The boat's electrical system and grounding conductor are not actually connected to the shoreside system when you use the 3.8 KVA IsoGuard as an isolation transformer. Power is transferred from the shoreside electrical system to the boat's electrical system by magnetic coupling. This means there is no direct electrical connection between the earth-grounded shore AC power and boat AC power systems. The shore grounding conductor is connected to a shield that is wound between the primary (shore) and secondary (boat) transformer windings. This shield assures isolation on the boat by providing a protective layer between primary and secondary windings within the transformer. In the unlikely event of a breakdown within the transformer, the shield can withstand the fault current of a properly sized shore supply circuit breaker long enough for the breaker to trip. In addition, by grounding one leg of the transformer secondary (X2) on board the boat, a "neutral" ground is established for the vessel's electrical system. When using the transformer, shoreline polarity is no longer a consideration and a shoreline polarity device is not necessary.

IMPORTANT SAFETY INSTRUCTIONS

SAVE THESE INSTRUCTIONS. This manual contains important safety and operating instructions for the IsoGuard. Read the entire manual before usage. Also read all instructions and cautions for and on the IsoGuard.

Warnings

WARNING — HIGH VOLTAGE

To avoid serious injury or death from high voltage electrical shock disconnect AC shore power before opening panel.

WARNING — FIRE HAZARD

Primary and secondary overcurrent protection and conductor sizing must be in accordance with manufacturer's installation instructions.

WARNING — SHOCK HAZARD

On board and in-water shock hazard. Transformer must be connected in accordance with manufacturer's installation instructions.

WARNING — FIRE HAZARD

Do not store equipment on or next to transformer. This unit is designed to operate hot and must have free air flow to prevent over heating or charring of adjacent material.

WARNING — ELECTRICAL SHOCK AND FIRE HAZARD

Cord grip connectors must be used to prevent wires from chafing on the metal case and causing an electrical short. See installation instructions for suitable connector types or call Charles Marine Products to order a connector kit.

Installation Precaution

Boat wiring is a complex task that can cause shock, corrosion and other hazards if not done properly by trained, experienced personnel. For more information on this subject contact the **American Boat and Yacht Council (ABYC)** or see the standards and regulations below:

American Boat and Yacht Council
E-8 “Alternating Current (AC) Electrical Systems on Boats”

3069 Solomon’s Island Road
 Edgewater, MD 21037
 Telephone: 410.956.1050
 FAX: 410.456.2737

NFPA Standard 302. National Fire Protection Association
“Pleasure and Commercial Motor Craft”

1 Batterymarch Park
 P.O. Box 9101
 Quincy, MA 02269-9401
 800.344.3555

Telephone:

Rules and Regulations for Recreational Boats. Excerpts from the United States Code (USC) and the Code of Federal Regulations (CFR) (U.S. Coast Guard Regulations) are available from the **American Boat and Yacht Council** listed above.

Note: Installation of the IsoGuard must be made in accordance with all applicable standards and regulations.

Environmental Precaution

The IsoGuard is intended for installation inside an engine room or elsewhere inside the boat. Make sure that the location will not subject the unit to rain, snow, excessive moisture, or excessive heat.

NOTICE

This device is ignition protected in accordance with U.S. Coast Guard regulations under 33 CFR 183.410.

Application Precaution

These units are intended for hard-wired, permanent, on-board applications. Use of attachments not recommended or sold by Charles Marine Products may result in risk of fire, electrical shock or personal injury.

Damaged Unit Precaution

Do not operate the IsoGuard if it has received a sharp blow, been dropped, immersed in water or otherwise damaged. See the section in this manual on *Warranty & Customer Service* for repair information.

Disassembly Precaution

Do not disassemble the IsoGuard. See the sections in this manual on *Maintaining the IsoGuard, Troubleshooting the IsoGuard* and *Warranty & Customer Service*.

INSTALLING THE ISOGUARD

Ratings and Connections

The 3.8 KVA IsoGuard is designed for 120 or 240 volt input, 120, 120/240 (3 wire) or 240 volt output and 50 or 60 Hz operation in order to provide maximum flexibility in a multitude of applications. Both the primary (input) and

secondary (output) windings may be reconnected for various voltages as shown below. The unit is rated at 3.8 KVA in order to be compatible with 16 ampere, 50 Hz European dockside power sources.

The following diagrams do not include all variations of the IsoGuard. Contact Charles Marine Products for additional information.

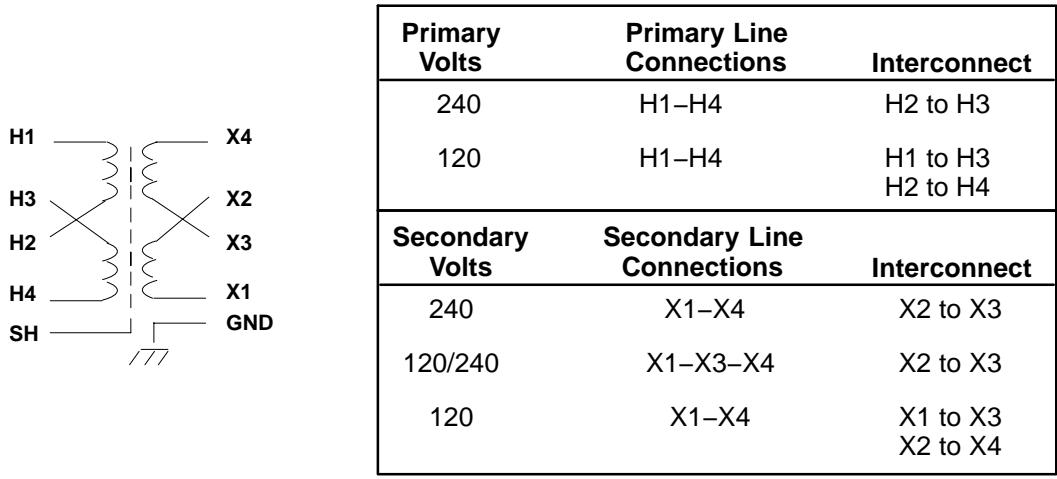

Figure 1. Schematic and Connections

Choosing an Electrical Wiring Method

There are two wiring methods that can be used to install the IsoGuard as an isolation transformer in accordance with *ABYC E-8 Alternating Current (AC) Electrical Systems on Boats*. A third method, also in accordance with *ABYC E-8*, can be used to install the IsoGuard as a polarization transformer if desired. The third method is not preferred, because wiring the unit in the manner described circumvents the AC grounding conductor isolation between shore and boat power and may require the use of a galvanic isolator to reduce galvanic corrosion.

Note: Figure 2 through Figure 5 are reprinted with permission from the American Boat and Yacht Council (ABYC). To obtain the complete standard referenced or any other standards contact:

*American Boat and Yacht Council: 3069 Solomon's Island Road
Edgewater, MD 21037
Telephone: 410.956.1050
FAX: 410.456.2737*

Wired as an Isolation Transformer

The only difference between Method 1 and Method 2 is that in Method 2, a Ground Fault Protector (GFP) must be used instead of just a circuit breaker, and the shore grounding conductor is not wired past the inlet of the boat. Method 1 is most commonly used.

Note: This diagram does not illustrate a complete system. Refer to the appropriate ABYC text.

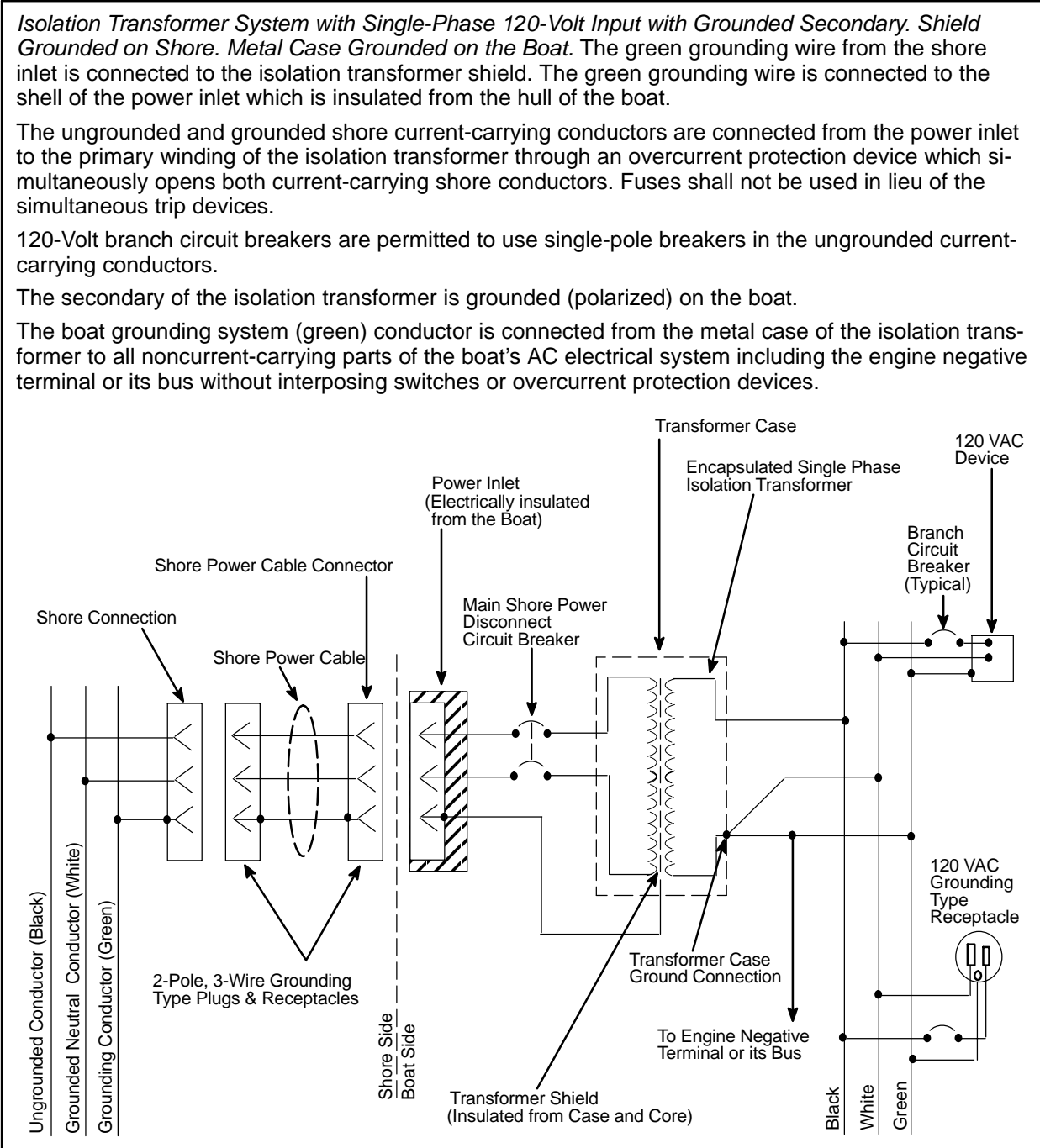

Figure 2. Electrical Diagram – Method 1 (see Figure 6 for Wiring Connections)

Note: This diagram does not illustrate a complete system. Refer to the appropriate ABYC text.

Isolation Transformer System with Single-Phase 240-Volt Input, 120/240-Volt Single-Phase Output with Boat Grounded Secondary. Shield Grounded on Shore and Metal Case Grounded on Boat. The Ungrounded shore current-carrying conductors are connected from the power inlet to the primary winding of the isolation transformer through an overcurrent protection device which simultaneously opens both current carrying conductors. Do not connect the shore neutral. Fuses shall not be used in lieu of simultaneous trip devices.

240-Volt branch circuit breakers and switches simultaneously open all current-carrying conductors.

120-Volt branch circuit breakers are permitted to use single-pole breakers in the ungrounded current-carrying conductors.

Polarization of conductors must be observed in all circuits.

The green grounding wire from the shore is connected to the shore power inlet shell which is insulated from metal-hulled boats. Do not connect the shore green wire to the boat ground.

The grounded neutral from the secondary of the isolation transformer and the case of the transformer are connected to the system ground, neutral conductor and engine negative terminal or its bus.

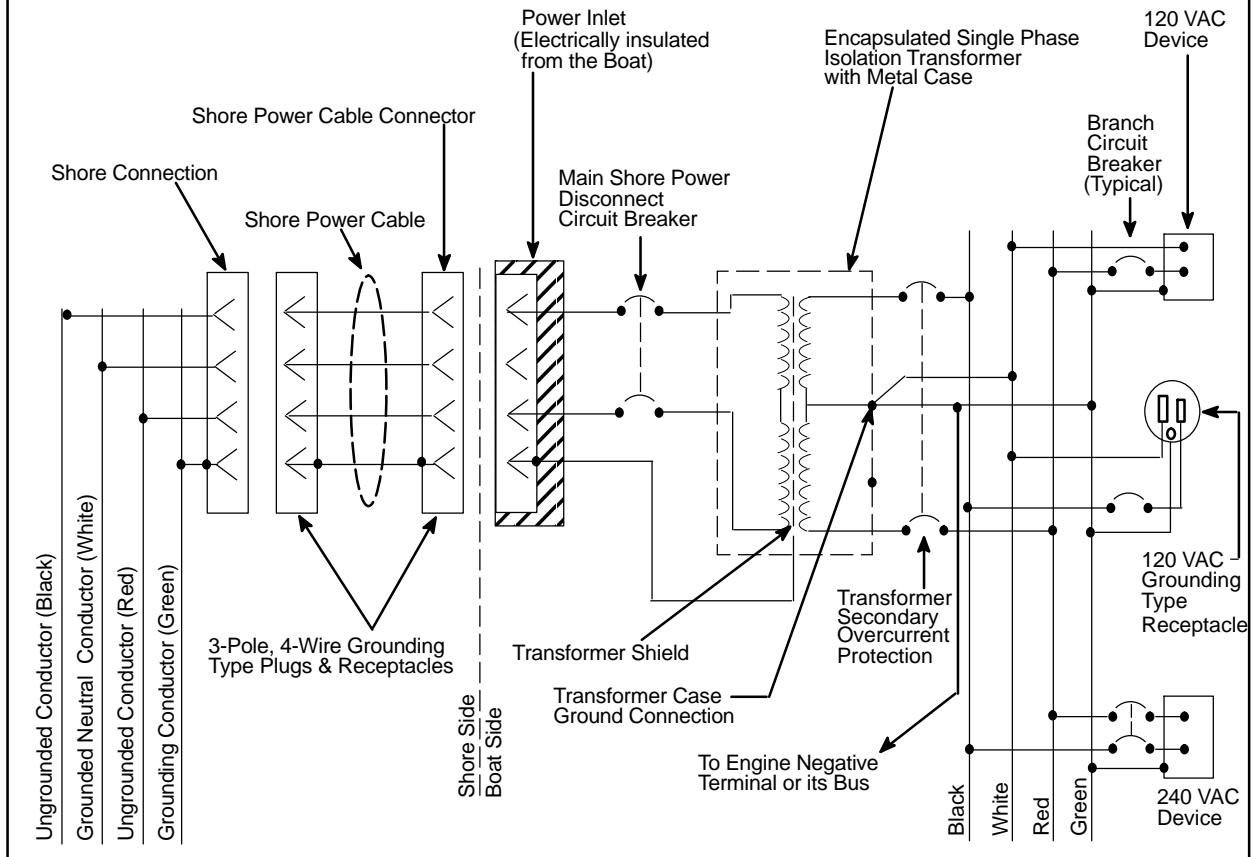

Figure 3. Electrical Diagram – Method 2 (see Figure 7 for Wiring Connections)

Note: This diagram does not illustrate a complete system. Refer to the appropriate ABYC text.

Isolation Transformer System with Single-Phase 120-Volt Input with Ground Fault Protection and Grounded Secondary. Shield and Metal Case Grounded on the Boat. The green grounding wire from the shore inlet is not connected to the isolation transformer shield or metal case. The green grounding wire is connected to the shell of the power inlet which is insulated from the hull of the boat.

The ungrounded and grounded shore current-carrying conductors are connected from the power inlet to the primary winding of the isolation transformer through a ground fault protection device which simultaneously opens both current-carrying shore conductors. Fuses shall not be used in lieu of the simultaneous trip devices.

120-Volt branch circuit breakers are permitted to use single-pole breakers in the ungrounded current-carrying conductors.

The secondary of the isolation transformer is grounded (polarized) on the boat.

The boat grounding system (green) conductor is connected from the shield and metal case of the isolation transformer to all noncurrent-carrying parts of the boat's AC electrical system including the engine negative terminal or its bus without interposing switches or overcurrent protection devices.

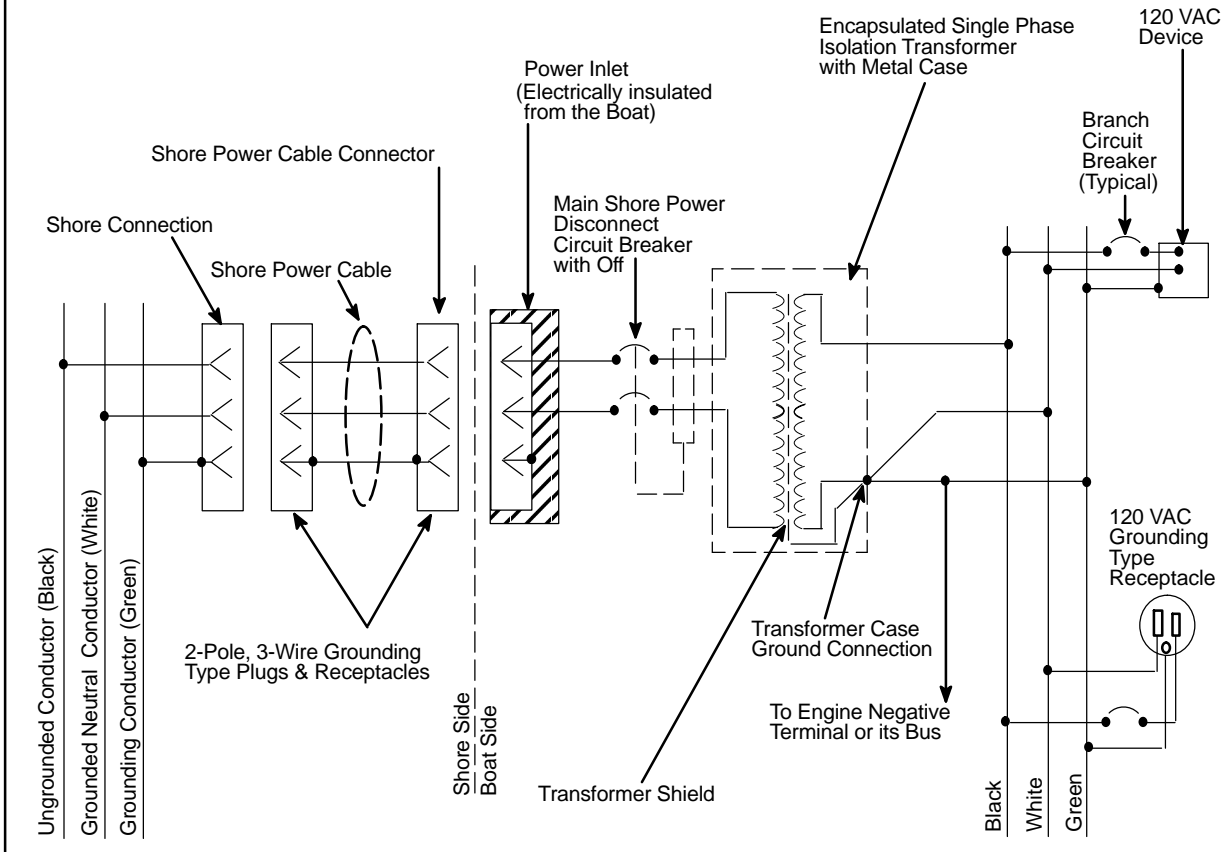

Figure 4. Electrical Diagram – Method 3 (see Figure 8 for Wiring Connections)

Note: This diagram does not illustrate a complete system. Refer to the appropriate ABYC text.

Isolation Transformer System with Single-Phase 240-Volt Input, 120/240-Volt Single-Phase Output, Ground Fault Protection and a Grounded Secondary. Shield and Metal Case Grounded on Boat. The ungrounded shore current-carrying conductors are connected from the power inlet to the primary winding of the isolation transformer through a ground fault protection device which simultaneously opens both current-carrying shore conductors. Fuses shall not be used in lieu of simultaneous trip devices.

240-Volt branch circuit breakers and switches simultaneously open all current-carrying conductors.

120-Volt branch circuit breakers are permitted to use single-pole breakers in the ungrounded current-carrying conductors.

Polarization of conductors must be observed in all circuits.

The green grounding wire from the shore power inlet is not connected to the Isolation transformer shield or case nor to the boat ground.

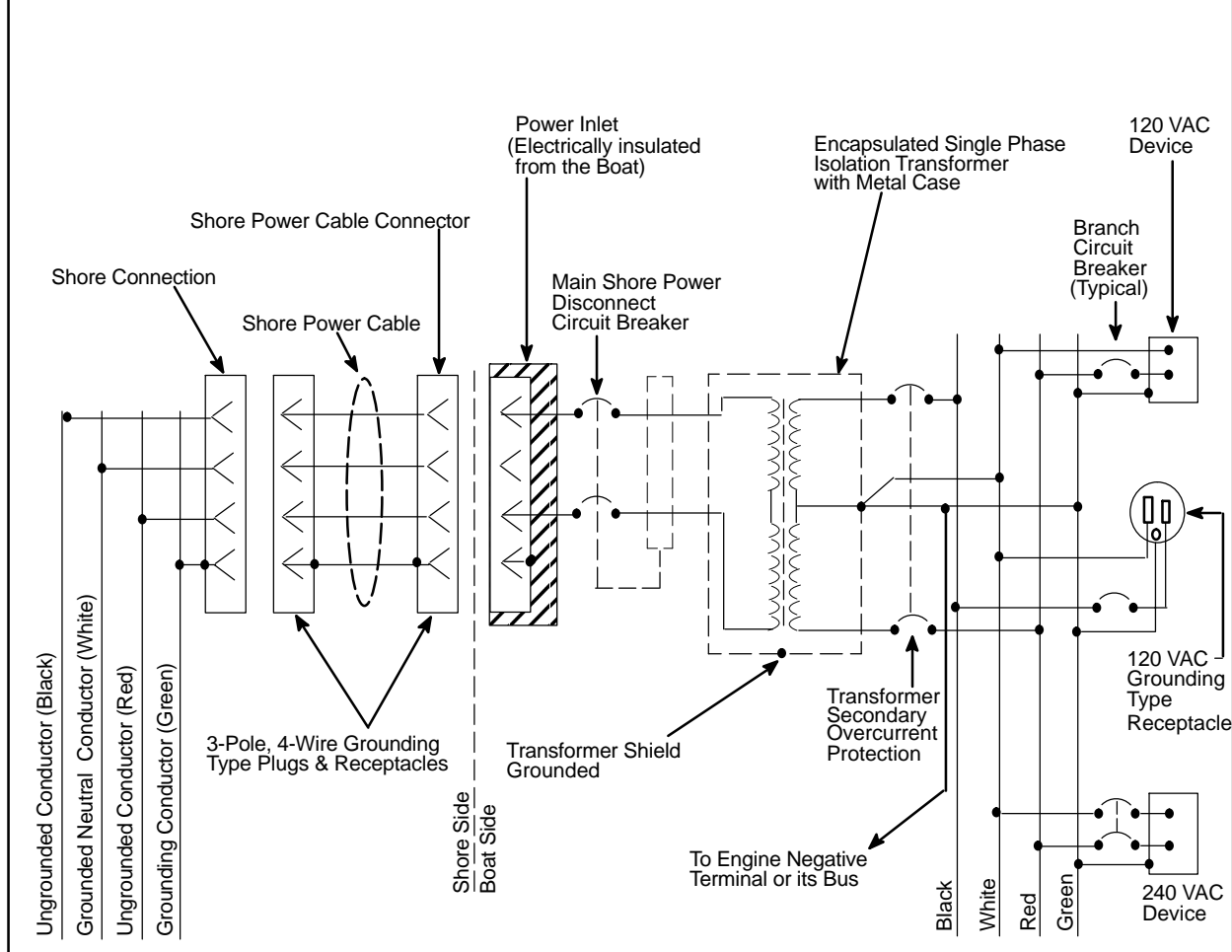
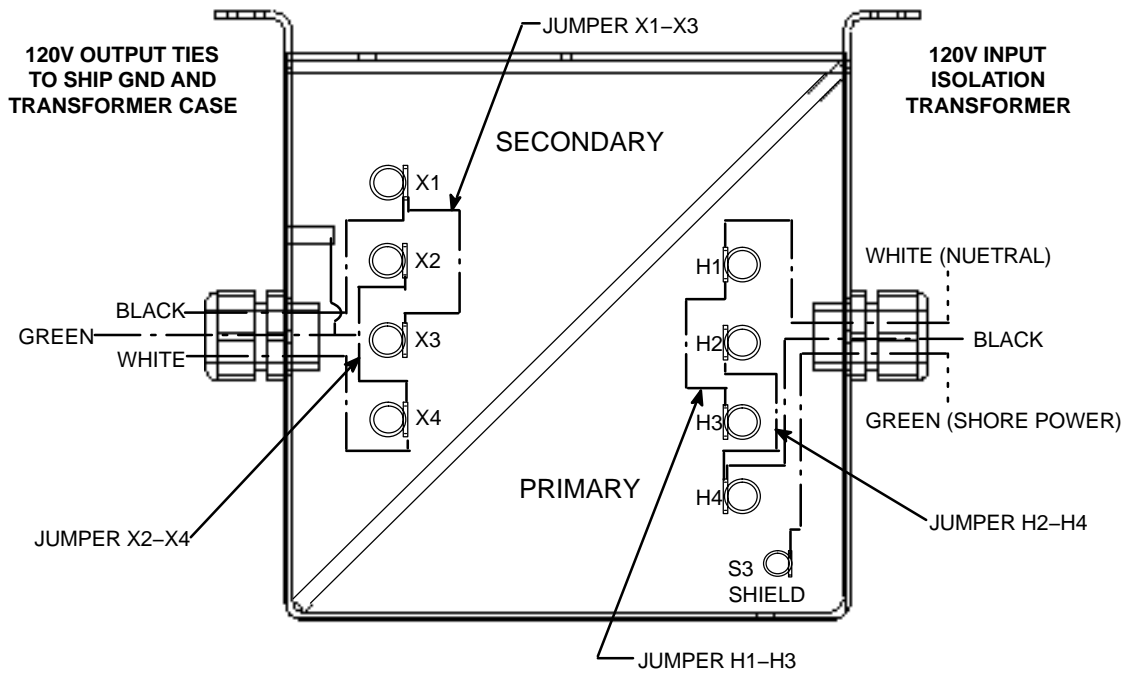
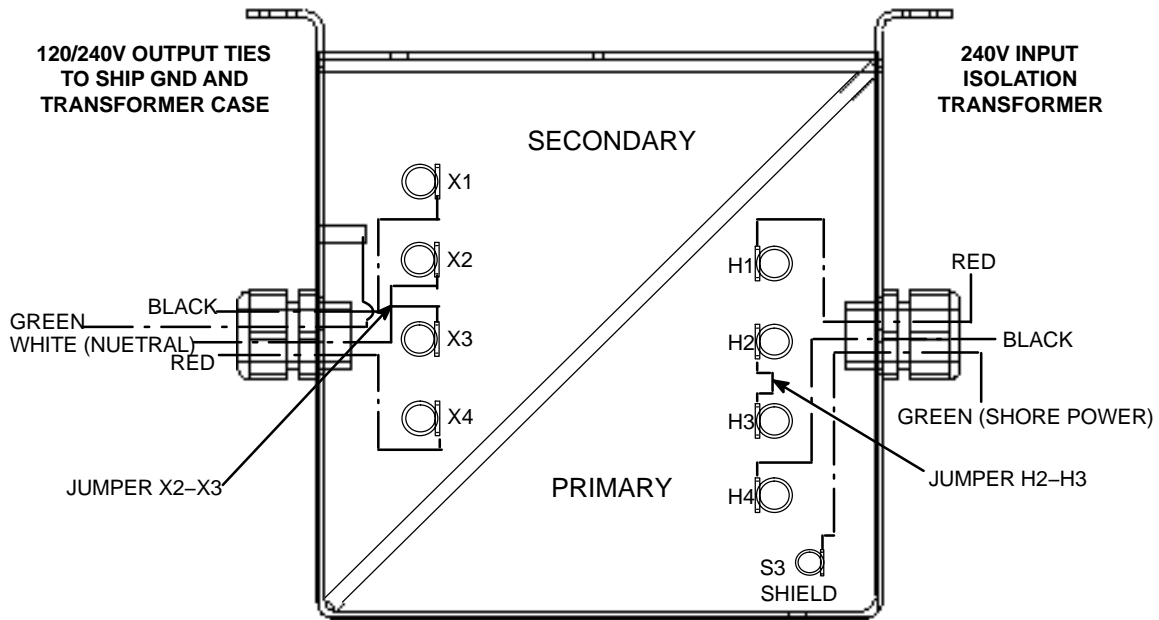

Figure 5. Electrical Diagram – Method 4 (see Figure 9 for Wiring Connections)



— - — Wire is fed through the cord grip connector.

Figure 6. 120V Input, 120V Output – Method 1 (See Figure 2 for Electrical Diagram)



— - — Wire is fed through the cord grip connector.

Figure 7. 240V Input, 120/240V Output – Method 2 (See Figure 3 for Electrical Diagram)

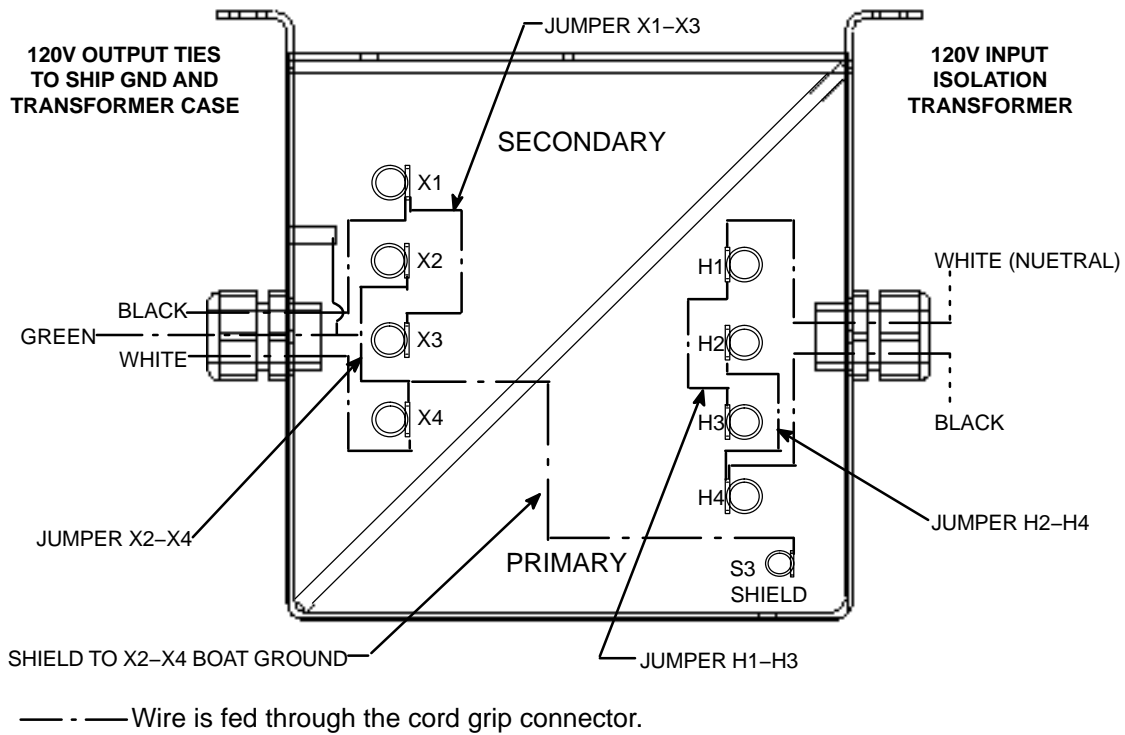

Figure 8. 120V Input, 120V Output – Method 3 (See Figure 4 for Electrical Diagram)

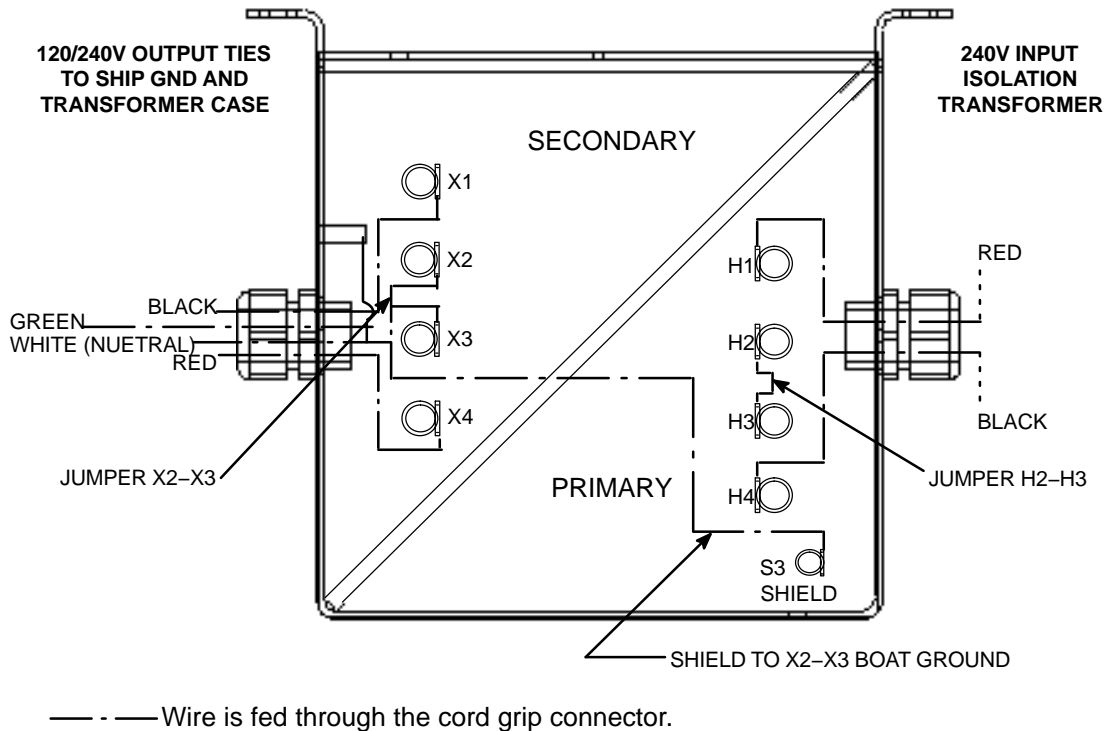

Figure 9. 240V Input, 120/240V Output – Method 4 (See Figure 5 for Electrical Diagram)

Securing Covers

After all connections and terminations have been made, the access cover should be re-installed using all hardware supplied.

Applying Power

Power should only be applied after all connections and terminations have been made and the access cover is secure. Plug in the shore power and turn on the appropriate circuit breakers to apply power. Refer to the section on *Proper Operation*.

OPERATING THE ISOGUARD

Safety First

Follow all precautions in the *IMPORTANT SAFETY INSTRUCTIONS* section in this manual. Pay close attention to the DANGER, WARNING and CAUTION boxes both within this manual and labeled on the unit.

Proper Operation

When properly installed and connected, the IsoGuard will provide isolation between shore and boat power while maintaining a one to one turns ratio (shore voltage equals boat voltage).

MAINTAINING THE ISOGUARD

WARNING – HIGH VOLTAGE

To avoid serious injury or death from high voltage electrical shock, disconnect the AC shore power before attempting any maintenance or cleaning.

No adjustment or maintenance is required for the IsoGuard other than periodic cleaning of the outside cabinet with a dry cloth and inspecting all connections for tightness and corrosion by a qualified service person.

TROUBLESHOOTING

If there is a problem with the IsoGuard, first check that all connections are accurate and secure, and retest. If all connections are good, contact Charles Marine Products for technical assistance.

WARRANTY & CUSTOMER SERVICE

Warranty

The CHARLES Marine & Industrial Group warrants the unit will be free from defects in materials and workmanship that cause mechanical failure for one (1) year, as set forth in the Limited Warranty. Notice of any alleged defect in material or workmanship must be provided within thirty (30) days of discovering the problem, and within the warranty period. Follow the procedure outlined below to obtain warranty service.

Service Center and Repair Correspondence

Note: Do not attempt to service the unit. Contact the Service Center.

To contact the Service Center via telephone directly:

800-830-6523 (Toll Free)

217-932-2317 (Voice)

217-932-2473 (FAX)

Call to obtain a Returned Materials Authorization (RMA) number prior to returning any unit to Charles Industries.

Return the unit for repairs to the Service & Repair Center address below:

Charles Industries, Ltd.

Marine & Industrial Group

503 NE 15th Street

Casey, IL 62420-2054
USA

Correspondence can be sent to Corporate Headquarters via the address below:

Note: Do not return the unit to this address.

Charles Industries, Ltd.
Marine & Industrial Group
5600 Apollo Drive
Rolling Meadows, IL 60008-4049
USA
847-806-6300
www.charlesindustries.com

SPECIFICATIONS

The specifications for the IsoGuard are listed in Table 1.

Table 1. IsoGuard Specifications

Feature	Specification
Input Voltage	120/240 VAC
Input Current	30/16 Amps
Output Voltage	120/240 VAC
Output Current	30/16 Amps
KVA Continuous	3.8 KVA
Operating Frequency	50/60 Hertz
°C Rise Insulation System 220A	120° C
Insulation Class	H
% Impedance	3.4
Operating Temperature	0° to 50° C
Approximate Weight	60 pounds
Height	8 inches
Width	10.5 inches
Width (excluding the mounting flange)	8 inches
Depth	10.5

