

IMC Series™

Intelligent Battery Charger

INSTALLATION INSTRUCTION & OWNER'S MANUAL

Model 93-IMC80-A
93-IMC100-A
93-IMC120-A



INTRODUCTION AND APPLICATION 3
 Manual Purpose 3
IMPORTANT SAFETY INSTRUCTIONS 3
 Environmental Precaution 4
 Location Precautions 4
 Application Precaution 4
 Damaged Unit Precaution 4
 Disassembly Precaution 4
 Maintenance/Cleaning Precaution 4
 Personal Safety Precautions 5
 Preparing to Charge Precautions 5
 Grounding Precautions 5
MOUNTING 6
WIRING 7
 Wire Recommendations 7
 Connection Points 8
IMC Series OPERATION 10
 Battery Charger Terminology 11
 Soft Touch Button Setting 11
 Turning the IMC Series™ ON/OFF 11
 Setup Mode 11
 Setup Types 12
 Procedure for Setup Mode 12
 Important Notes 13
 Configuration Storage 13
 Display Screens 16
 Remote Display Operation 20
 Lamp Test Mode 20
 Cooling and Blower Operation 20
ALARMS 21
 Alarm Silence 21
 Deeply Discharged Battery Recovery 21
 Battery Temperature Compensation During Charging 22
 Connection 22
 Operation 22
LIMP HOME MODE 23
MAINTAINING THE IMC Series 23
 Fuse Replacement 23
IMC Series FAILURE AND REPLACEMENT 23
WARRANTY AND SERVICE 24
 Warranty 24
 Service Center and Repair Correspondence 24
SPECIFICATIONS 25
FACTORY DEFAULT SETTINGS 26

INTRODUCTION AND APPLICATION

Thank you for purchasing the IMC Series™. We hope you will be satisfied with this charger and it provides many years of exceptional service.

The IMC Series™ is a heavy duty, state of the art, microprocessor controller, four bank Battery Charger that allows easy custom user configuration and setup.

This charger has the following features that make it configurable to fit most applications.

- Can charge four battery banks
- Bright Vacuum Florescent Display (VFD) to indicate information such as output amps, battery voltage, temperature (Celsius or Fahrenheit) and alarms
- 12 or 24 VDC output (user selectable) by battery bank
- Pre-configured for Gel, Flooded Lead Acid, AGM or NiCAD batteries. (or adjust and modify the preset configuration to meet your needs).
- Universal AC input (120/240 VAC, 50/60 Hz) automatic voltage selection
- Available in 20, 40, 60, 80, 100 & 120 amp sizes
- Memory button that stores all settings and can be transferred to other chargers in case of failure or upgrade.
- Audio Alarm (user selectable: On/Off)
- Soft Touch Capacitive User Interface that is resistant to dust and dirt contamination.
- Double heavy duty Form C alarm battery contacts
- Equalization (Flooded Lead Acid and NiCAD only)
- Deeply Discharged Battery Recovery system to safely recharge a deeply discharged battery.
- "Battery Reversed (automatic shutoff)... no fuse blowing." (indicator and relay)
- Cool touch, rugged case with retained screws on the covers
- -20 to +55 C (-4 to 131 F) ambient operating temperature with no derating
- Over Temperature detection and shutdown (prevents damage due to overheating)
- Optional fully functional Remote display with keypad and Audible alert
- Optional easy to install Battery Temperature Sensors for each battery bank

Manual Purpose

With your personal safety in mind, this manual lists important safety precautions first, then covers installation, operation, maintenance, troubleshooting, warranty, and service information.

IMPORTANT SAFETY INSTRUCTIONS

SAVE THESE INSTRUCTIONS. This manual contains important safety and operating instructions for the IMC Series™. Read the entire manual before usage.



To avoid serious injury or death from high voltage electrical shock disconnect AC shore power before opening panel.



Pour éviter la blessure ou la mort sérieuse de la décharge électrique à haute tension, débrancher le pouvoir de rive de courant alternatif avant d'ouvrir le panneau.

WARNING

RISK OF EXPLOSIVE GASES! WORKING IN THE VICINITY OF A LEAD ACID BATTERY IS DANGEROUS. BATTERIES GENERATE EXPLOSIVE GASES DURING NORMAL BATTERY OPERATION. THEREFORE IT IS OF UTMOST IMPORTANCE THAT EACH TIME BEFORE USING YOUR IMC Series™ YOU READ THIS MANUAL AND FOLLOW THE INSTRUCTIONS EXACTLY.

To reduce risk of battery explosion, follow these instructions, those of the battery manufacturer, and the manufacturer of any equipment you use in the vicinity of the battery. Review cautionary markings on these products and on the engine.

AVERTISSEMENT

LE RISQUE DE GAZ EXPLOSIFS ! LE FONCTIONNEMENT A PROXIMITE D'UNE PREMIERE PILE ACIDE EST DANGEREUX. LES PILES PRODUISENT DES GAZ EXPLOSIFS PENDANT L'OPERATION DE PILE NORMALE. DONC C'EST D'IMPORTANCE D'UPMOST QUI CHAQUE FOIS AVANT D'UTILISER VOTRE COLLECTION D'IMC VOUS LISEZ CE MANUEL D'UTILISATION ET SUIVEZ LES INSTRUCTIONS EXACTEMENT.

Pour réduire le risque d'explosion de pile, suivre ces instructions, ceux—là du fabricant de pile, et le fabricant de n'importe quel équipement que vous utilisez à proximité de la pile. Réexaminer des marques d'avertissement sur ces produits et sur le moteur.

Environmental Precaution

The IMC charger™ is intended for installation in an area protected from rain and/or snow.

Location Precautions

When choosing a location for the IMC Series™ the following precautions must be adhered to:

1. Locate the IMC Series™ as far away from the battery as DC cables will permit.
2. Never place the IMC Series™ directly above the battery being charged; gases from the battery will corrode and damage the IMC Series™.
3. Never allow battery acid to drip on the IMC Series™ when reading gravity or filling the battery.
4. Do not operate the IMC Series™ in an enclosed area or restrict ventilation in any way.
5. Do not set a battery on top of the IMC Series™.
6. This battery charger should be installed so that it is not likely to be contacted by people. Don't touch the top of the IMC charger when operating, hot temperatures present a risk of burns.

Application Precaution

These units are intended for hard-wired, permanent, installation. Use of attachments not recommended or sold by the Charles Marine & Industrial Group may result in risk of fire, electrical shock or personal injury.

Damaged Unit Precaution

Do not operate the IMC Series™ if it has received a sharp blow, been dropped, immersed in water or otherwise damaged. See the section in this manual on *Warranty and Customer Service* for repair and replacement information.

Disassembly Precaution

Do not disassemble the IMC Series™. See the sections in this manual on *Maintaining the IMC Series™*, *Troubleshooting*, and *Warranty and Service*.

Maintenance/Cleaning Precaution

To reduce risk of electrical shock, disconnect the IMC Series™ from AC power and batteries before attempting any maintenance or cleaning.

Personal Safety Precautions:

Adhere to the following personal safety precautions when installing or working with an IMC Series™ :

1. Someone should be within voice range or close enough to come to your aid when you work near a lead acid battery.
2. Have plenty of fresh water and soap nearby in case battery acid contacts skin, clothing, or eyes.
3. Wear complete eye protection and clothing protection. Avoid touching eyes while working near a battery.
4. If battery acid contacts skin or clothing, wash them immediately with soap and water. If acid enters the eye, flood the eye with cold, running water for at least ten minutes and get medical attention immediately.
5. Never smoke or allow a spark or flame in the vicinity of the battery or engine.
6. Do not drop a metal tool onto the battery. It may spark or short circuit the battery or other electrical parts that can cause an explosion.
7. Remove all personal metal items such as rings, bracelets, necklaces and watches when working near a lead acid battery. A battery can produce short circuit currents high enough to weld a ring or the like to metal, causing a severe burn.
8. Do not use the IMC Series™ for charging dry cell batteries that are commonly used with home appliances. These batteries may burst and cause personal injury and property damage.
9. **NEVER** charge a frozen battery.

Preparing to Charge Precautions

CAUTION

To reduce risk of injury, charge only lead acid, gel, NiCAD or AGM batteries. Other types of batteries may burst, causing personal injury and damage.

PRUDENCE

Pour réduire le risque de blessure, la charge seulement premier acide, le gel, NiCad ou les piles d'AGM. Les autres types de piles peuvent éclater, causant la blessure et les dommages personnels.

Before charging a battery with the IMC Series™, read the following precautions:

1. If it becomes necessary to remove the battery from the boat to charge, first remove the grounded terminal from the battery. Make sure all accessories in the vehicle are off, so as not to cause an arc.

2. Be sure the area around the battery is well ventilated while the battery is being charged. Gas can be forcefully blown away using a piece of cardboard or other non-metallic material as a “hand fan”.
3. Clean battery terminals. Be careful to keep corrosion from coming in contact with eyes.
4. Add distilled water in each cell until battery acid reaches levels specified by the battery manufacturer. This helps purge excessive gas from cells. Do not overfill. For a battery without cell caps, carefully follow the manufacturer’s recharging instructions.
5. Study all battery manufacturer’s precautions, such as removing or not removing cell caps while charging and recommended rates of charge.
6. Determine the voltage of the battery by referring to the owner’s manual. Make sure that the output voltage selector switch is set at the correct voltage. If the charger has an adjustable charge rate, charge the battery initially at the lowest rate.

Grounding Precautions

IMC Series™ is intended to be permanently mounted and must have a grounding conductor.

1. The IMC Series™ should be connected to a metal, grounded, permanent wiring system. An equipment-grounding conductor should be run with the circuit wiring and connected through the IMC Series™ housing grommets to the equipment grounding (GRN) terminal on the IMC Series™.
2. Connections to the IMC Series™ should comply with all local codes and ordinances.

MOUNTING

The IMC Series™ charger is designed to be wall mounted with vents down on a bulkhead in a protected area away from rain or spray and as close to the batteries as possible.

While the IMC Series™ is designed to maintain a cool touch exterior, sufficient clearance must be allowed for heat dissipation and cooling. It is strongly recommended that the IMC Series™ be mounted in such a way that there is at least 6 inches of free air clearance on the bottom.

Choosing Mounting Hardware

As with any marine equipment, secure mounting is of utmost importance. The bolts or screws used to secure the IMC Series™ charger must be 1/4 inch in diameter, backed with a flat washer, and kept vibration-free with a split-ring lock washer. If using bolts, they must be long enough to be secured on both sides of the bulkhead. If using screws, they should be at least 1 inch long. All hardware should be corrosion-resistant.

Mounting the IMC Series™ Charger

All corrosion-resistant mounting hardware should be readily available. Follow the steps below to mount the IMC Series™ charger to the bulkhead while referring to Figure 1.

| Step | Action |
|------|---|
| 1. | Hold the IMC Series™ charger mounting template vertically flush on the bulkhead. |
| 2. | Mark the mounting holes. |
| 3. | Remove the IMC Series™ charger mounting template and save. |
| 4. | Drill the “A”, “B” and “D” mounting holes. |
| 5. | Insert the mounting hardware half-way into the drilled “A” mounting holes. |
| 6. | Hang the charger on the “A” keyholes, these holes are only used to expedite mounting, not intended to secure charger to bulkhead. |
| 7. | Insert the mounting hardware for the “B” and “D” labeled holes to lock the charger down. |
| 8. | Secure all mounting hardware. |

WARNING

The IMC Series™ blower exhausts the heat the IMC Series™ generates during operation through the vent holes on the bottom of the case. In addition, this exhausted air helps cool the case. Blocking the airflow on the bottom of the case will result in charger overheating and shutdown.

AVERTISSEMENT

La soufflerie de Collection d'IMC épuise la chaleur la Collection d'IMC produit pendant l'opération par les trous de conduit dessous du cas. Par ailleurs, ces aides épuisées d'air refroidissent le cas. Bloquer le flux d'air dessous du cas aura pour résultat la surchauffe de chargeur et l'arrêt.

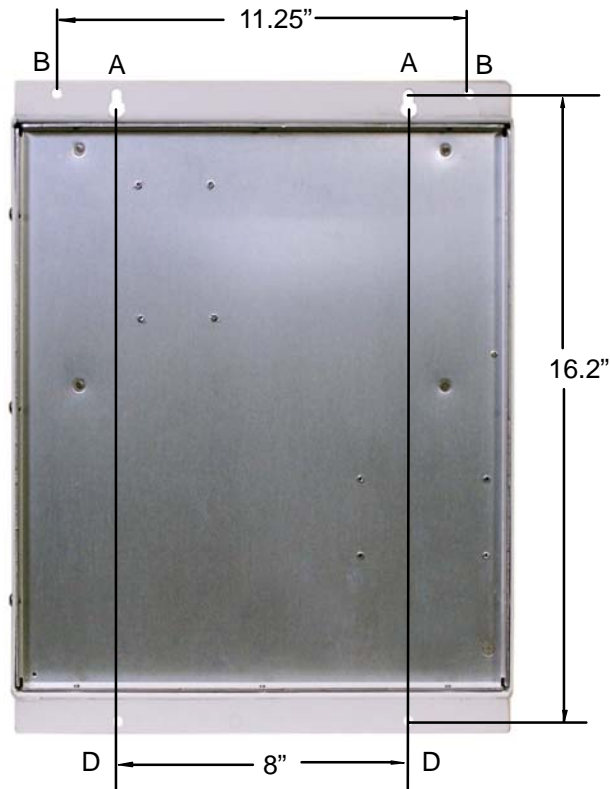

Figure 1. Mounting Dimensions

WIRING**DANGER**

To maintain protection from fire, only use conductors recommended in this manual.

**DANGER**

Pour maintenir la protection du feu, seulement les conducteurs d'usage ont recommandé dans ce manuel.

Wire Recommendations

The wire gauges in Table 1 are the minimum requirement for making wire connections.

Note: Use only copper or copper-clad wire. Do not use steel or aluminum wire.

Table 1. Minimum Wire Gauge Requirements

| Model | 120VAC Input | | | 240VAC Input | | | DC output | |
|-------------|--------------|-------|-------|--------------|--------|--------|-----------|---------|
| | 25' | 50' | 100' | 25' | 50' | 100' | 15' | 25' |
| 93-IMC80-A | 10 AWG | 8 AWG | 8 AWG | 12 AWG | 12 AWG | 10 AWG | 4 AWG | 2 AWG |
| 93-IMC100-A | 6 AWG | 6 AWG | 4 AWG | 10 AWG | 8 AWG | 8 AWG | 2 AWG | 1/0 AWG |
| 93-IMC120-A | 4 AWG | 4 AWG | 4 AWG | 8 AWG | 6 AWG | 6 AWG | 1/0 AWG | 2/0 AWG |

Alarm Contacts should be 26 AWG for all models

Proper wire is provided with optional temperature sensor

Connection Points

The wiring is housed in the AC and DC wiring Compartments. Access these compartments by loosening the retained screws as shown and pulling down slightly on the Wiring Compartment Cover. Replace all covers and tighten screws after installation is complete.



Loosen screws to access main AC and DC wiring compartments

Figure 2. Main Wiring Compartment Access

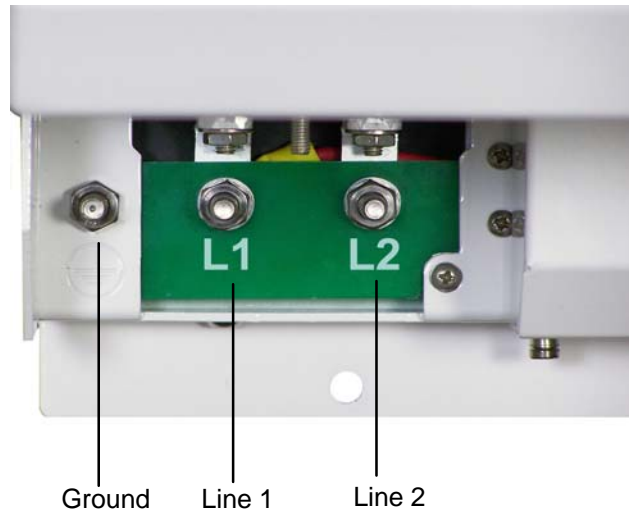

For 120VAC operation, connect Neutral/White to L1 and Line/Black to L2
Use only UL listed terminal terminated wires, torque down to 20 in-lbs

Figure 3. AC Cover Removed from IMC

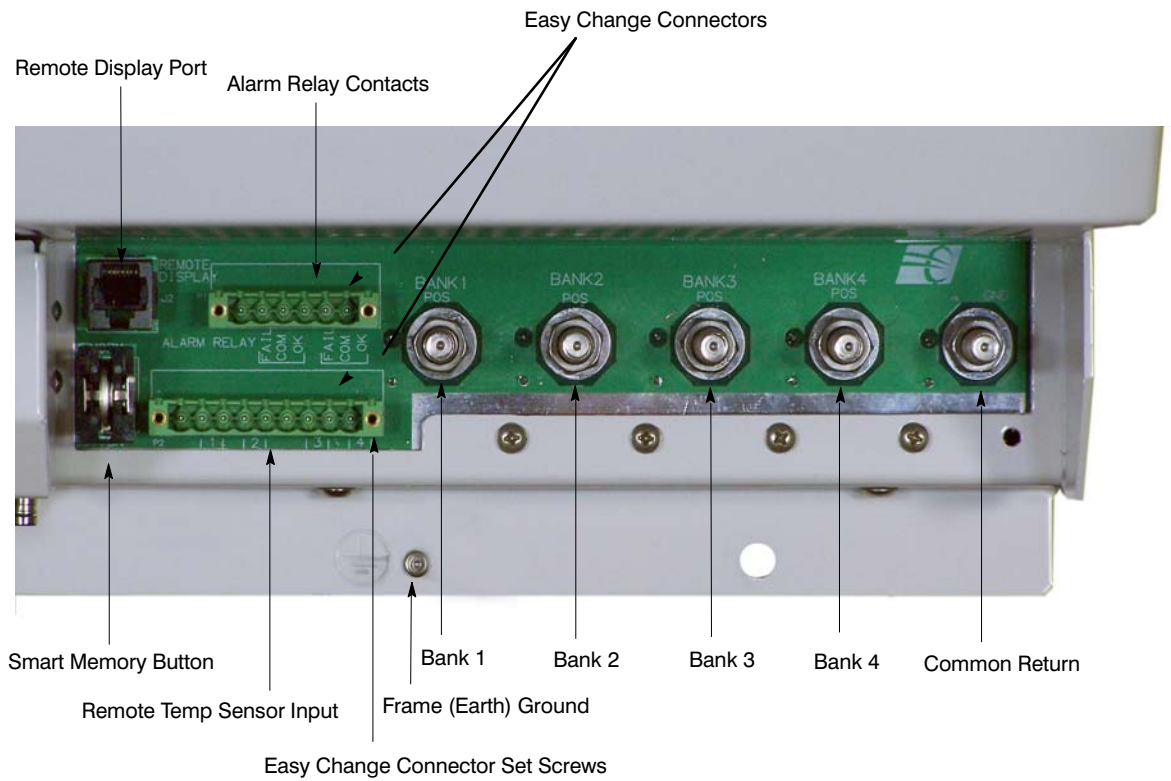

Figure 4. DC Cover Removed from IMC

All Easy Change Connector blocks may be removed for convenient wiring. Loosen the set screws and gently pull the plug away from the header. Insert wire into connection blocks and tighten as appropriate. After wiring the Easy Change Connector block, insert into mating header and tighten the outer set screws to avoid disconnection from vibration.

Table 2. Wiring Connection List

| Type of Connection | Description |
|-------------------------------------|---|
| Input | 120/240 VAC system auto select |
| Frame Ground | Connect to Earth Ground |
| Output | 12 VDC or 24 VDC set through <i>Setup</i> menu |
| Alarm Connections | Optional: Each alarm has a Common (C), Pass (closed when no alarm), and Fail (closed when in alarm) connection |
| Remote Temp. Sensor (93-RMTEMP01-A) | Optional: Connect to Remote Temp. Sensor (if purchased separately). Observe polarity. Place the non-conductive ring lug over any battery terminal to measure battery temperature. |
| Remote Display (93-RMDISP01-A) | Optional: Remove dirt cap and plug in remote display to unit. Use a standard "straight" Cat-5E Ethernet cable (max 500 feet). Do not use a Cat-5E "cross-over" cable. Remote display mirrors charger display including touch buttons. Note: This port is not an Ethernet port. Do not connect to Ethernet type equipment to this port. |

IMC Series OPERATION

The IMC Series™ is a completely automatic battery charging system. However, there are still a few parameters that need to be configured by the user prior to use. If this is the first time using the system, the system will initially default into SETUP mode.

If the system has been previously setup, all the settings are recalled and the IMC Series™ is automatically configured to the previous settings.

Upon Power up (or the return of AC power, if missing), the IMC Series™ will enter Bulk Mode (Lead Acid, Gel, or AGM) or Equalize Mode (NiCAD), and stay in that mode for the duration set by Bulk Duration (Lead Acid, Gel, or AGM) or Equalize Duration (NiCAD).

After the Bulk or Equalize Duration completes, the IMC Series™ will enter Float Mode to maintain the batteries. The IMC Series™ will stay in Float Mode until the AC is removed or the battery voltage drops approximately 1.0 volts [12 Volt mode] or 2.0 volts [24 Volt mode] below Float voltage for approximately five minutes. After the time delay, the IMC Series™ will reenter the Bulk [Equalize] Mode for the duration set.

In order to achieve proper operation, the IMC must be connected to a suitable source of AC input power. When using AC voltage input less than 95VAC, this battery charger will automatically reduce the DC output power by turning off internal modules. The charger will display an error stating "REDUCED OUTPUT, CALL FOR SERVICE" until the AC voltage input has been reset and is above 95VAC.

Battery Charger Terminology

This explanation of terms will assist in understanding battery charger operation.

| Term | Definition |
|---|--|
| 3-Stage Charging/ Single Stage Charging | By setting the Bulk Mode and Float Mode to different values, the IMC Series™ will effectively do 3-stage charging. If Single Stage Charging is desired, set the Bulk and Float Mode settings to the same voltage level. |
| Bulk Duration | The time the system is in Bulk Mode. With NiCAD batteries this is called Equalize Duration. |
| Bulk Mode | The higher output voltage setting for rapidly charging discharged batteries. This is also called the Equalize Mode when using NiCAD batteries. |
| Equalize Cycle (Lead Acid & NiCAD batteries only) | When set, this is the number of days between Equalization. Lead Acid and NiCAD have two different operations. When using Lead Acid batteries, the voltage is raised to 15.5 VDC [12 Volt mode] or 31.0 [24 Volt mode] for 1 hour to equalize the batteries. When using NiCAD batteries, the IMC Series™ will set the output voltage to the setting of the Equalize Mode [Bulk Mode] for the duration specified by the Equalize Duration [Bulk Duration]. |
| Float Mode | The lower output voltage setting for maintaining batteries once the battery is charged. |

Soft Touch Button Setting

Simply lightly touch the button with your finger. The charger will sense your finger. Pressing hard on the button is not desirable. Remove finger from button completely before pressing next button. Avoid laying your finger from the button to the metal housing as this may cause the button not to sense your finger properly.

Turning the IMC Series™ ON/OFF

Press and hold the ON or OFF button for approximately 3 seconds to turn on/off the IMC Series™.

Note: If the charger was left in the “ON” state, the charger will restart to the “ON” state when AC Input Power is applied. The same holds true for the “OFF” state. If the charger was left in the “OFF” state, it will restart in the “OFF” state when AC Input Power is applied.

Setup Mode



Setup mode allows the user to select and customize as necessary the parameters of the IMC Series™. All setup mode operations are available using the following buttons:

| Keypad Button | Description |
|---------------|--|
| ENTER ↵ | Press to enter <i>Setup Mode</i> or advance to next setup category. |
| UP arrow ↑ | Select the desired operation. |
| DOWN arrow ↓ | Hold button to repeat. |
| SILENCE ← | Silences audio alarm In <i>Setup Mode</i> , returns to previous setup category. |

Setup Types

There are two basic types of setup selections as described below.

Table 3. Setup Types

| Setup Type | Display Output |
|--|---|
| <p><u>Type 1 – Selectable Selection Setup:</u> This type of setup allows the user to select a specific option. Example would be <u>12</u> or <u>24</u> VDC output. Use the UP/DOWN arrow keys to move the small battery icon to the desired selection. Use the ENTER (↵) button to move to the next set-up category. Use the SILENCE (←) button to move to the previous setup category.</p> |  <p>Selected Value: 12V</p> |
| <p><u>Type 2 – Variable Selection Setup:</u> This type of setup allows the user to select a desired operation from a large range. Example would be maximum output amperage. Use the UP/DOWN arrow keys to select the desired value from the range shown. The current value is shown on the right and an analog range percentage bar is shown on the bottom. Hold the UP/DOWN arrows for repeat action. Use the SILENCE (←) button to move to the previous setup category. Use the ENTER (↵) button to move to the next setup category. OFF and NOW are available on some categories. If available on certain categories, the OFF can be reached by pressing the DOWN button until “OFF” appears on the right side. Similarly, NOW can be reached by pressing the UP button until “NOW” appears on the right side.</p> |  <p>Range: 5 to 40 amps Current Value: 22 amps</p> |

Procedure for Setup Mode

- Setup the system by pressing ENTER (↵). This will turn the charger’s output to OFF while the system is in Setup mode. Once Setup Mode is complete, the charger’s output will automatically restart.
- Enter the password (if enabled). Use the UP/DOWN arrow keys to select number, hit enter key to advance.
- The first menu displays a summary of all four banks. Each bank may be set for 12V (12V mode), 24V (24V mode) or off. After a few moments, the display will switch to the bank’s battery type: FBO (Fixed Bank Output), LA (Lead Acid), NCD (NiCad), AGM, GEL. Select “EDIT” to change any bank’s parameters. Select “NEXT” to change general charger features.
- When editing each bank, the menu displays the 12/24 VDC battery output selection menu. Using the Up/Down arrow keys as explained in a Type 1 selection above, select the desired output voltage. Press ENTER (↵) to advance to the next menu.
- The second menu displays the Battery Type selection menu. There are 4 battery types and a fixed bank output mode with only 2 types shown at a time. Use the Up/Down arrow keys to select the desired battery types. Note the small arrow on the display indicates the direction of the other hidden battery types. Press ENTER (↵) to advance to the next menu. See note on fixed bank output later in this manual.

Note: Fixed Bank Output mode is only available on Bank #1.

| Step | Action | Result |
|------|--|--|
| 1. | At the end of setup, there is an option to Save or Cancel the changes just made. Cancel returns to the previously unchanged values. Save stores the values in the memory button. |  |

Important Notes

- The Charger output is turned off during Setup and will automatically restart after Setup mode is completed.
- Keypad Timeout: If no keys are pressed for approximately 5 minutes, the system will return to normal operation, which is equivalent to pressing the *Cancel* key.
- The system must be Setup before the 1st operation. *Cancel* is replaced with *Restart*. Keypad Timeout is disabled.
- The Smart Memory Button must be in-place for Setup to operate properly.
- Switching battery types will restore all battery related setting on that bank to factory defaults.

Configuration Storage

All the configuration and settings are stored in the *Smart Memory Button*. This non-volatile memory can be moved from charger to charger if necessary.

During system startup and operation, the *Smart Memory Button* is referenced for setting and configuration necessary to operation the charger. For this reason, the *Smart Memory Button* must be present at all times during charger operation.

Table 4. Setup Menu Options

| Menu Option | Type | Description |
|-----------------|------------|--|
| Battery Voltage | Selectable | Set to the nominal voltage of the battery connected. Warning: <i>Battery Voltage must be set properly. Failure to set the charger to the proper battery voltage range will permanently damage the charger and the batteries and may cause a risk of fire.</i> Avertissement: <i>Tension de pile doit être réglée convenablement. L'échec pour régler le chargeur à la gamme de tension de pile correcte endommagera d'une façon permanente le chargeur et les piles et peut causer un risque de feu.</i> |
| Battery Type | Selectable | Set to the type of battery connected. <i>Note: A small arrow in the lower corner of the display screen indicates that additional battery selections are available. FBO (Fixed Bank Output), LA (Lead Acid), NCD (NiCad), AGM, GEL.</i> <i>Note: FBO (Fixed Bank Output) is only available on bank 1.</i> |





The following selections are available from the Custom Settings Menu.





| Menu Option | Type | Description |
|---|----------|---|
| Bulk (Boost) or Equalize Voltage | Variable | <p>This value is displayed in VDC and increases in 0.1 volt steps. If lead acid, AGM or gel was selected as the battery type, Bulk (Boost) Voltage will be displayed. If NiCAD was selected as the battery type, Equalize Voltage will be displayed. Select the Bulk (Boost)/Equalize Voltage for the battery.</p> <p><i>Note: Using the Remote Temperature Gauge will reduce or increase the charger's maximum output voltage depending on the temperature.</i></p> |
| Float Voltage | Variable | <p>The voltage at which the battery is maintained once the Bulk (Boost) (lead acid, gel or AGM battery types) or Equalize (NiCAD battery type) charge is complete.</p> <p><i>Note: For single stage charging, set Bulk (Boost)/Equalize Voltage and Float Voltage to the same value.</i></p> <p><i>Note: Using the Remote Temperature Gauge will reduce or increase the charger's maximum output voltage depending on the temperature.</i></p> |
| Bulk Duration (lead acid, gel or AGM battery types) Equalize (NiCAD battery type) | Variable | <p>The time the IMC Series™ will stay in Bulk (Boost)/Equalize Voltage mode. This value is in days and increases in 0.1 day steps.</p> |
| Equalize Cycle (lead acid and Ni-CAD battery types only) | Variable | <p><u>Lead Acid Battery Type:</u></p> <p>Number of days between 1 hr Equalization cycles. During the equalization cycle, the voltage will be raised to 15.5 VDC (12 volt system) or 31.0 VDC (24 volt system) to help reform the batteries. As an example, setting the value to 25.0 days will run equalization for 1 hour every 25 days. Equalization will start at a random time.</p> <p><u>NiCAD Battery Type:</u></p> <p>For NiCAD batteries the equalize cycle is equivalent to the settings for equalize voltage and equalize duration set previously.</p> <p>This value is in days and increases in 1.0 day steps.</p> <p>This option can be turned OFF (lowest setting).</p> <p>This option can also be turned on NOW for immediate Equalization (highest setting). After the 1 hr equalization is complete, the Equalization will return to the OFF mode.</p> <p>Entering Setup during equalization automatically cancels the equalization operation.</p> <p>This option only available for Lead-Acid and NiCAD battery types.</p> |



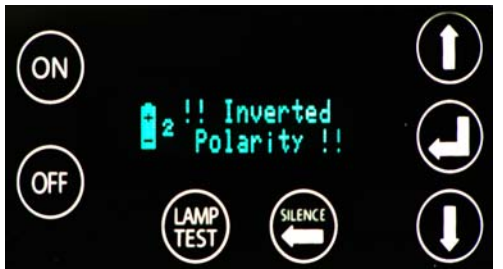

| Menu Option | Type | Description |
|-------------------------|------------|--|
| Maximum Amps | Variable | <p>Upper limit of the maximum output amperage to the battery. Use a smaller value for small batteries. Consult your battery manual for maximum charge rate in amperage.</p> <p>This value is in amps and increases in 1 amp steps.</p> <p>The charger may lower its output below the maximum amperage if the charger detects the batteries are sufficiently charged or to complete a charge in a more consistent manner.</p> <p><i>Note: There are short intervals that the charger may output more than the maximum amperage. During this time, the charger will slowly lower its output to the maximum level set point above.</i></p> <p><i>Note: If the charger detects a deeply discharged battery, the maximum output amperage will be significantly reduced. See selection about Deeply Discharged Battery Recovery.</i></p> |
| Display Temperature | Selectable | Selects Fahrenheit or Celsius units on the Temperature display screen |
| Audio Beep and Alarm | Selectable | Turns the Audio beep and the audio alarm on/off. |
| Password Enabled | Selectable | <p>Provides the ability to password protect the Setup menu. If this option is enabled a three-digit password will be required to change settings. Password protection is not a default setting and therefore needs to be enabled.</p> <p>If enabled:</p> <ul style="list-style-type: none"> – Use the UP/DOWN keys to change a digit and then press the ENTER (↵) key to move to the next digit. – Once a password is entered, a second entry is required for verification. If both password entries do not match, the message “Password Mismatch” will appear and the password will not be changed. – When both password entries match, Save Settings must be selected in order for this feature to be activated. The next time the Setup Menu is accessed, a password entry will be required. <p><i>Note: A password of “000” disables the password protection feature.</i></p> |
| Save Settings Cancel | Selectable | <p>Saves the current settings to the memory button...or...</p> <p> Cancels the current setting changes and reverts back to settings previously stored in the memory button.</p> |





Display Screens



Each of the display screens will appear in sequence. Automatically change after an brief display cycle. The software Version Screen only appears at initial power up.

| Description of Screen | Display Screen |
|---|--|
| <p><u>Software Version Screen</u> Upon initial power up, the software version screen is displayed for a few seconds. This information will be required when calling for Technical Support.</p> |  |
| <p><u>Model Screen</u> The model screen will appear next.</p> |  |
| <p><u>Logo Screen</u> The logo screen will periodically appear.</p> |  |
| <p><u>Battery Voltage and Temperature Screen</u> This screen displays the current battery voltage (as read by the charger) and the current amperage the charger is supplying to the battery. These values are updated periodically. If the optional remote temperature sensor is present, the battery temperature will also be displayed. Press UP/DOWN arrows to immediately force a bank change.</p> |  |
| <p><u>Error Screen</u> Example of a screen indicating an error condition exists. Refer to the <i>Alarms</i> section for more information.</p> |  |

| | |
|---|--|
| <p>Bank Voltage Summary</p> <p>Each bank's nominal output voltage (12VDC, 24VDC, or Off) is shown. This display alternates with Bank Battery Type Summary. Select EDIT to modify a bank.</p> <p>Select NEXT to move on to general charger option setup.</p> |  |
| <p>Bank Battery Type Summary</p> <p>Each bank's battery type is shown. The bank types are as follows: FBO=Fixed Bank Output, GEL=Gel Cell, LA=Flooded Lead Acid, AGM=Absorbed Glass Mat, NCD=NiCad, "-"=Bank not used. This display alternates with Bank Battery Type Summary. Select EDIT to modify a bank.</p> <p>Select NEXT to move on to general charger option setup.</p> |  |
| <p>Individual Bank Summary</p> <p>A bank's detail settings are displayed here. This includes the bank type, the nominal bank voltage, and the maximum amps. Select EDIT to modify this bank's characteristics.</p> <p>Select NEXT to move to the next bank.</p> |  |
| <p>Bank Enable</p> <p>Turns on/off a bank. Turn off banks that are not used to prevent alarms and aid in charging.</p> <p>Turn on banks that are connected to batteries.</p> |  |
| <p>Bank Voltage Select</p> <p>Select the nominal output voltage of the battery bank.</p> <p>Warning: Battery Voltage must be set properly. Failure to set the charger to the proper battery voltage range will permanently damage the charger and the batteries and may cause a risk of fire.</p> <p>Avertissement: Tension de pile doit être réglée convenablement. L'échec pour régler le chargeur à la gamme de tension de pile correcte endommagera d'une façon permanente le chargeur et les piles et peut causer un risque de feu.</p> |  |

| | |
|---|--|
| <p>Bank Battery Type Select</p> <p>Select the battery type connected to this bank. Note there are multiple screens on this page by pressing the UP/DOWN arrows. Select the Battery type. If the battery type is unknown, GEL mode should be selected. Note the bank number in the upper right hand corner. [Fixed Bank Output mode: Fixed Bank Output mode is only available on Bank 1. If Fixed Bank Output mode is selected, Banks 2–4 are automatically turned off.]</p> |  |
| <p>Bank Output Voltage</p> <p>This screen allows the output voltage to be customized. Fixed Band Output mode has only a single setting. All other active modes have Bulk (Equalize) and Float settings. Press the UP/DOWN arrows to change the setting. You may return to default setting for the selected battery type by changing the battery type to another type and saving the settings. Then, re-enter the setup mode and reset the battery type back to its original value.</p> |  |
| <p>Maximum Output Amperage</p> <p>Set the maximum output amperage for this bank. Care should be used when setting the Maximum Output Amperage. If the battery's capacity is limited, select a lower output amperage. Likewise, if the battery's capacity is large, a higher maximum output amperage should be selected.</p> |  |
| <p>Temperature Select</p> <p>Sets the temperature reading to Fahrenheit or Celsius.</p> |  |

| | |
|---|--|
| <p><u>Audio Beep and Alarm</u> Turns On/Off the audio alarm and touch screen indicator beep. Use the "SILENCE" (←) button to silence the sound during an alarm condition.</p> |  |
| <p><u>Password Enable</u> Enables/Disables the password. When enabled, correct password is required to enter setup menu.</p> |  |
| <p><u>Password Entry and Re-entry</u> Refer to password entry early in this manual for instructions. Password must match to be accepted. "000" is not available.</p> |  |
| |  |

| | |
|---|--|
| <p><u>Password mismatch</u> Displayed when passwords entered during setup do not match.</p> |  |
| <p><u>Save and Cancel Settings</u> Select Save to store your settings to the smart memory button and make your settings active. Select Cancel to revert back to previously stored settings. Note: Initial setup changes "Cancel" to "Re-enter Data"</p> |  |

Remote Display Operation

The Remote Display is identical in operation and displays the same information as on the charger. Use either the buttons on the charger or the remote display to control the charger.

The remote display may be plugged in at any time. Should the logo screen be missing or some small blocks appear incorrect on the display, they will be corrected within 4 minutes of normal operation of the main screens (Logo Screen, Temperature Screen, Battery Voltage Screen).

Lamp Test Mode

Press and hold the LAMP TEST button to verify the operation of the following:

- Display will flash
- Alarm will sound
- Alarm relay will change to FAIL state. Use this mode to help verify alarm wiring
- Blower will turn on.

Release the LAMP TEST button to cease testing.

During the Lamp Test, the DC output to the batteries is not affected.

Note: Lamp Test is not available in Setup Mode.

Cooling and Blower Operation

The IMC Series™ requires sufficient airflow for cooling to maintain operation. This is especially important on the air vents, located on the bottom of the charger. Failure to allow sufficient airflow will cause the charger to over-heat and shutdown.

The internal cooling blower is temperature controlled and will turn on and off as needed.

ALARMS

Alarm Silence

If the audio alarm is sounding, it may be silenced by pressing the “*Silence* ← ” button. This will silence the audio alarm for any current alarms. Any new alarms will again restart the audio alarm. Regardless of the state of the audio alarm, all alarms will still be displayed on the screen.

Note: The audio alarm is only available if the audio beep is enabled (see *Setup Menu*).

Table 5. Alarms

| Alarm | Description | Possible reason |
|-----------------------------|--|---|
| Inverted Polarity Alarm | If the DC is connected to the IMC Series™ with reversed polarity, the system will immediately declare an alarm, flash the display, and indicate reverse polarity has been detected. Correct polarity to clear the alarm. | DC connection connected with reverse polarity. |
| Battery Failure | If the IMC Series™ detects an incorrect or defective battery, the Battery Failure alarm will activate. | Battery not connected, dead battery or battery voltage too high. DC Fuse blown. |
| Over Temperature | Should the internal temperature of the IMC Series™ rise to 100C, the IMC Series™ output will temporary shut down until the unit cools to below 90C | Insufficient cooling of the charger. Allow sufficient air clearance for ventilation. Clean charger air vents. |
| Smart Memory Button Missing | Smart Memory button is missing or has been placed backwards in the holder. | IMC Series™ needs the memory button to operate. Replace missing button or correctly insert memory button into holder. |
| Equalizing | Unit is performing an Equalization for 1 hour on the batteries | (see <i>Setup Menu</i> for more information) |
| Reduced Output | The charger has detected a battery that is very drained and has reduced the maximum current output to a safe level. | (see <i>Deeply Discharged Battery Recovery</i> for more information) |

Deeply Discharged Battery Recovery

Connecting a deeply discharged battery to the IMC Series™ will cause the IMC Series™ to enter battery recovery mode. The IMC Series™ will slowly charge the deeply discharged battery, limiting the output current until the battery can take full charge. During this time, you will see the charger displaying “*Reduced Output*” to prevent battery from over-heating. The recovery may take several hours, depending on the size and response of the battery.

During battery recovery, the IMC Series™ alarms may activate and then reset. This is due to the deeply discharged battery’s operation with high internal resistance. Over time, if the battery recovers, the alarms will not be activated. It is strongly recommended to turn off the alarms during battery recovery.

The IMC Series™ will not recover a damaged battery. A damaged battery must be replaced.

Note: Regarding battery life span – A deeply discharged battery has a significantly shortened operational life span. It is strongly recommended to keep your batteries charged at all times.

Battery Temperature Compensation During Charging

Requires optional Battery Temp Sensor.

Connection

Connect the Battery Temp Sensor to the IMC Series™ connector in the Connection compartment observing the correct polarity. The lead with the red band is positive.

Place the temperature sensing ring lug over the battery terminal screw. The temperature ring lug should be the lug closest to the head of the screw or nut. Since the ring lug is electrically isolated, it may be placed on either the positive or negative lead of the battery that will be connected to the IMC Series™.

Operation

Once connected, the IMC Series™ will automatically detect the Battery Temp Sensor within one minute and adjust the output accordingly to optimize the battery charging. It will take at least one complete cycle of the display to show the battery temperature.

The Battery temperature will be shown on the bank voltage display screen. If the temperature is not displayed, check for proper polarity and connection.

The Battery Temp Sensor will adjust the output voltage to the battery based on the temperature measured. The output voltage may be slightly greater or less than the Max Output Voltage. As the battery temperature changes, the IMC Series™ will optimize the charge automatically.

With regard to Max Output Voltage, at higher temperatures, the output voltage is slightly reduced. At lower temperatures, the output voltage is slightly increased.

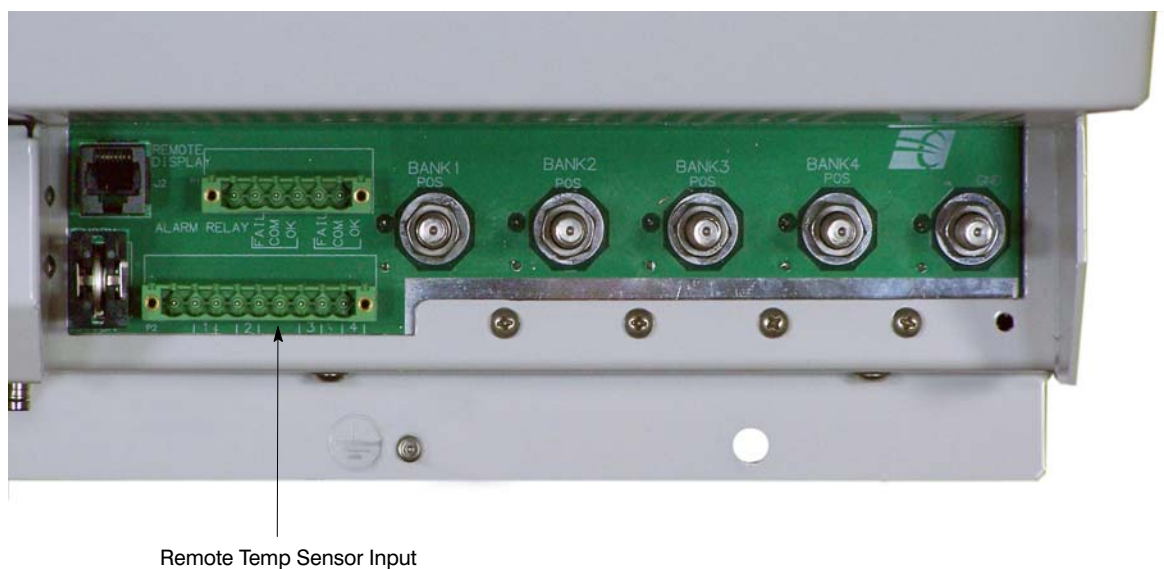

Figure 5. Battery Temp Sensor Connections in the IMC Series™

Battery Temp Sensor



Figure 6. External Battery Temp Sensor

LIMP HOME MODE

On 40 amp or larger chargers, the IMC will continue to operate, but at a lesser output, if a power module fails. This allows for the charger to continue to provide power, but at a reduced output amperage.

When the charger detects a failed module, the battery temperature portion of the display is replaced with an information scroll and the charger enters alarm mode. Limp Home mode can be reset by cycling the AC power or entering and then exiting SETUP mode. If the defective power module is still present, the IMC will re-enter reduced output mode and an alarm will be displayed.

Chargers that Limp Home mode has activated should be returned to Charles Industries, Ltd. for repair.

MAINTAINING THE IMC Series

The IMC Series™ is designed to operate with minimum maintenance.

- Periodically verify the air vents are open and clear of obstructions. Clean if necessary.
- Wipe the case off with a soft cloth.

Fuse Replacement

There are no user replaceable fuses.

IMC Series FAILURE AND REPLACEMENT

At Charles, we take pride in designing and building high quality, tough products. As such, it is rare that a charger will fail.

However, sometimes a charger does fail. In this case, you can quickly restore the same configuration to the replacement charger as follows:

1. Transfer the current settings by removing the Smart Memory Button from the failed charger and installing it into the new charger. The Smart Memory Button is located under the protective cap in the Main Wiring Compartment. Once transferred, the new charger will assume the same configuration as was on the failed charger prior to the failure.
2. Power down both systems. Remove the protective cap on both systems and transfer the Smart Memory Button from the failed charger to the new charger. Replace the protective cap.

3. Disconnect the Easy Change Connectors. Depending on how the system is wired, changing may be as simple as removing the plug by unscrewing the set-screws and moving the plug to the new charger.
4. For assistance and before returning the IMC Series™ for repair, call the technical support line listed at the end of this manual.

WARRANTY AND SERVICE

Warranty

The CHARLES Marine & Industrial Group warrants the unit will be free from defects in materials and workmanship that cause mechanical failure for three (3) years, as set forth in the Limited Warranty. Notice of any alleged defect in material or workmanship must be provided within thirty (30) days of discovering the problem, and within the warranty period. Follow the procedure outlined below to obtain warranty service.

Service Center and Repair Correspondence

Note: Do not attempt to service the unit. Contact the Service Center.

To contact the Service Center via telephone directly:

800-830-6523 (Toll Free)
217-932-2317 (Voice)
217-932-2473 (FAX)

Call to obtain a Returned Materials Authorization (RMA) number prior to returning any unit to Charles Industries.

Return the unit for repairs to the Service & Repair Center address below:

Charles Industries, Ltd.
Marine & Industrial Group
503 NE 15th Street
Casey, IL 62420-2054
USA

Correspondence can be sent to Corporate Headquarters via the address below:

Note: Do not return the unit to this address.

Charles Industries, Ltd.
Marine & Industrial Group
5600 Apollo Drive
Rolling Meadows, IL 60008-4049
USA
847-806-6300
www.charlesindustries.com

SPECIFICATIONS

The IMC Series™ meets the following regulatory specifications:

- **FCC Class A:** This device complies with part 15 of the FCC Rules. Operation is subject to the following two conditions: 1.) This device may not cause harmful interference, and 2.) this device must accept any interference received, including interference that may cause undesired operation.
- **UL 1236 Marine Listed**
- **ABS Type Approved**

Assembly location: United States of America

The operating specifications of the IMC Series™ are listed in Table 6.

Table 6. Specifications

| Feature | Specification |
|----------------------------------|---|
| Input Voltage | 120/240 VAC, 50–60 Hz |
| Input Voltage Selection | Auto |
| Input Power (93-IMC80-A) | 3000W |
| Input Power (93-IMC100-A) | 3750W |
| Input Power (93-IMC120-A) | 4500W |
| DC Output Voltage | 12/24VDC User Select |
| DC Output Amperage (93-IMC80-A) | 5–80 amps User configurable |
| DC Output Amperage (93-IMC100-A) | 5–100 amps User configurable |
| DC Output Amperage (93-IMC120-A) | 5–120 amps User configurable |
| Power Factor Correction | Active PFC=> 98% at full power |
| Efficiency | Approximately 85% af full power |
| | |
| Connectors | |
| AC Input | Stainless steel studs |
| DC Output | Stainless steel studs |
| Alarm and Temperature sensors | Pressure clamp with Easy Change Connector |
| | |
| Wiring compartments | Separate AC & DC wiring compartments |
| Battery types | Lead Acid (flooded), NiCAD, Gel, AGM |
| Equalization | Lead Acid (flooded) and NiCAD only |
| Maximum Output voltage | Default or User Selectable |
| Parameter and Setting Storage | Non-volatile Smart Memory Button |
| Dimensions (centimeters) | 28.5 deep x 43.0 high x 35.1 wide |
| Dimensions (inches) | 11.2 deep x 16.9 high x 13.8 wide |
| Weight | 93-IMC80-A = 35lbs, 93-IMC100-A = 40lbs, 93-IMC120-A = 45lbs |
| Case Material | Powder Coated Aluminum |
| Operating Temperature Range | –20 to +55 C (–4 to 131 F) – no derating |
| Alarm Relay | Active when alarm present |
| Alarm Relay Contact Rating | 8 Amps (max 265 VAC or 30 VDC) |

FACTORY DEFAULT SETTINGS

Table 7 shows the factory default settings using a 12V battery. Table 8 shows the factory default settings using a 24V battery.

Table 7. Factory Default Settings with a 12V Battery

| Variable Settings | Default | Units |
|--------------------------------------|------------|---------|
| Gel (Bulk Mode) | 14.2 | Volts |
| Gel (Float Mode) | 13.6 | Volts |
| NiCAD (Equalize Mode) | 14.5 | Volts |
| NiCAD (Float Mode) | 14.0 | Volts |
| AGM (Bulk Mode) | 14.2 | Volts |
| AGM (Float Mode) | 13.4 | Volts |
| Lead Acid (Bulk Mode) | 14.5 | Volts |
| Lead Acid (Float Mode) | 13.1 | Volts |
| Bulk/Equalize Duration | 0.2 | Days |
| Equalize Cycle | 30.0 | Days |
| Equalize Voltage * † (Lead Acid) | 15.5 | Volts |
| Equalize Time * † | 1.0 | Hours |
| Temperature | Fahrenheit | Degrees |
| Audio Alarm | On | |
| Password | Disabled | |
| * Not a changeable parameter | | |
| † Lead Acid and NiCAD batteries only | | |

Table 8. Factory Default Settings with a 24V Battery

| Variable Settings | Default | Units |
|----------------------------------|------------|---------|
| Gel (Bulk Mode) | 28.4 | Volts |
| Gel (Float Mode) | 27.2 | Volts |
| NiCAD (Equalize Mode) | 29.0 | Volts |
| NiCAD (Float Mode) | 28.0 | Volts |
| AGM (Bulk Mode) | 28.4 | Volts |
| AGM (Float Mode) | 26.8 | Volts |
| Lead Acid (Bulk Mode) | 29.0 | Volts |
| Lead Acid (Float Mode) | 26.2 | Volts |
| Bulk/Equalize Duration | 0.2 | Days |
| Equalize Cycle | 30.0 | Days |
| Equalize Voltage * † (Lead Acid) | 31.0 | Volts |
| Equalize Time * † | 1.0 | Hours |
| Temperature | Fahrenheit | Degrees |
| Audio Alarm | On | |

| | | |
|---|----------|--|
| Password | Disabled | |
| * <i>Not a changeable parameter</i> | | |
| † <i>Lead Acid and NiCAD batteries only</i> | | |

